

GBU2006 THRU GBU2010

SINGLE PHASE 20.0AMPS.GLASS PASSIVATED BRIDGE RECTIFIERS

FEATURE

- . UL Listed Under Recognized Component Index, File Number E338195
- . Glass passivated chip junctions
- . High case dielectric strength
- . Low Reverse Leakage Current
- . High surge current capability
- . Ideal for Printed Circuit Board Applications

MECHANICAL DATA

- . Case: GBU
- . Case Material: Molded Plastic.
UL Flammability Classification Rating 94V-0
- . Terminals: Pure tin plated, Lead free.
Leads solderable per MIL-STD-750, Method 2026.
- . Polarity: Molded on Body
- . Mounting: Through Hole for #6 Screw
- . Mounting Torque: 5.0 in-lbs Maximum

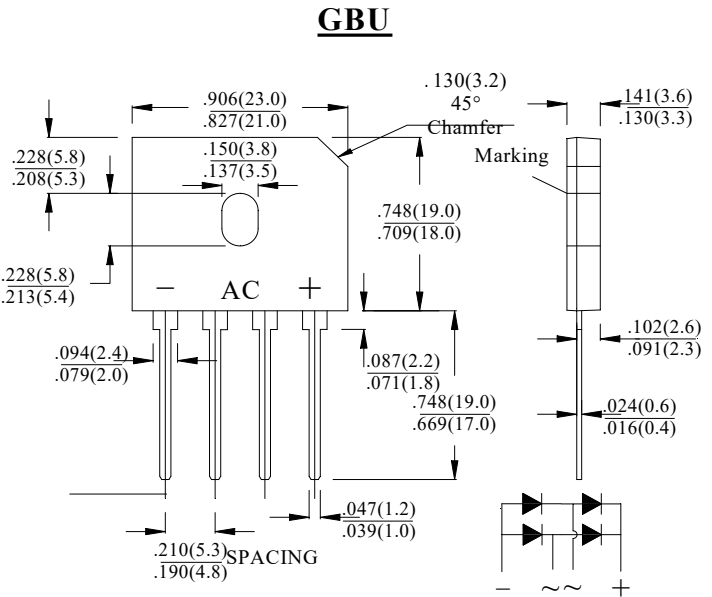

Dimensions in inches and (millimeters)

MAXIMUM RATINGS AND ELECTRICAL CHARACTERISTICS

Ratings at 25°C ambient temperature unless otherwise specified.

Single phase, half wave, 60Hz, resistive or inductive load. For capacitive load, derate current by 20%

| Type Number | SYM BOL | GBU2006 | GBU2008 | GBU2010 | units |
|---|-------------|---------------|---------|---------|---------------------------|
| Maximum Recurrent Peak Reverse Voltage | V_{RRM} | 600 | 800 | 1000 | V |
| Maximum RMS Voltage | V_{RMS} | 420 | 560 | 700 | V |
| Maximum DC blocking Voltage | V_{DC} | 600 | 800 | 1000 | V |
| Maximum Average Forward (with heatsink Note2) Rectified Current @ $T_C=100^\circ\text{C}$ (without heatsink) | $I_{F(AV)}$ | 20.0 3.6 | | | A |
| Peak Forward Surge Current 8.3ms single half sine-wave superimposed on rate load (JEDEC method) | I_{FSM} | 275 | | | A |
| Maximum Forward Voltage @20.0A DC Drop per element @10.0 A DC | V_F | 1.1 1.05 | | | V |
| Maximum DC Reverse Current @ $T_J=25^\circ\text{C}$ at rated DC blocking voltage @ $T_J=125^\circ\text{C}$ | I_R | 10.0 500.0 | | | μA |
| I^2t Rating for Fusing ($t < 8.3\text{ms}$) | I^2t | 313 | | | A^2Sec |
| Typical Junction Capacitance (Note 1) | C_J | 85 | | | pF |
| Typical Thermal Resistance (Note 2) | $R_{(JC)}$ | 2.2 | | | $^\circ\text{C}/\text{W}$ |
| Storage Temperature | T_{STG} | -55 to +150 | | | $^\circ\text{C}$ |
| Operating Junction Temperature | T_J | -55 to +150 | | | $^\circ\text{C}$ |

Note:

1. Measured at 1.0 MHz and applied reverse voltage of 4.0Vdc
2. Device mounted on 250mm x 250mm x 2.0mm Aluminum Plate Heatsink.

RATING AND CHARACTERISTIC CURVES

FIG.1-TYPICAL FORWARD CURRENT DERATING CURVE

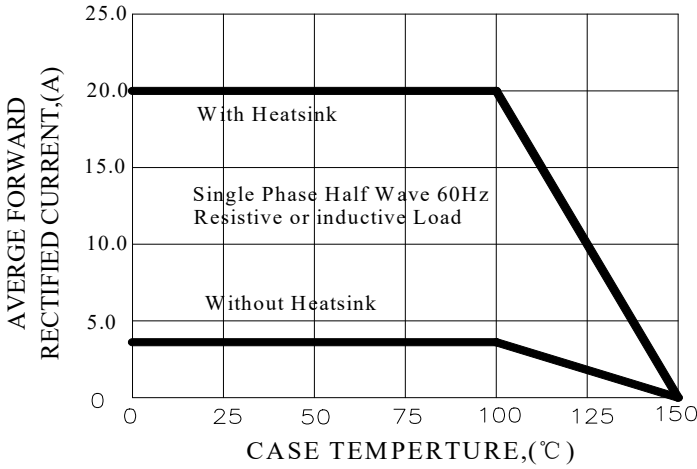

FIG.2-TYPICAL INSTANTANEOUS FORWARD CHARACTERISTICS

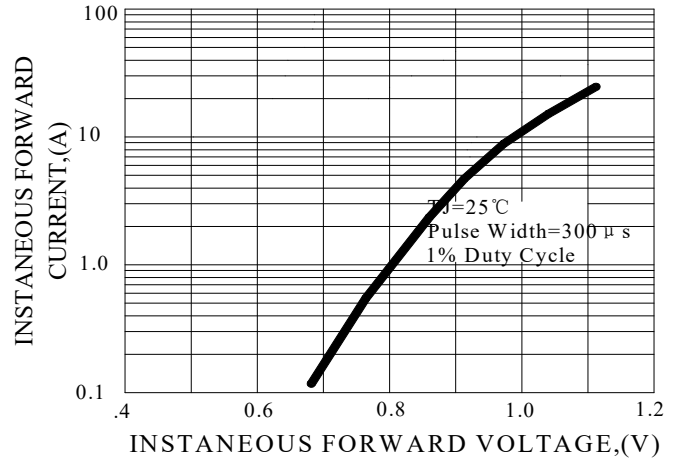

FIG.3-MAXIMUN NON-REPETITIVE FORWARD SURGE CURRENT

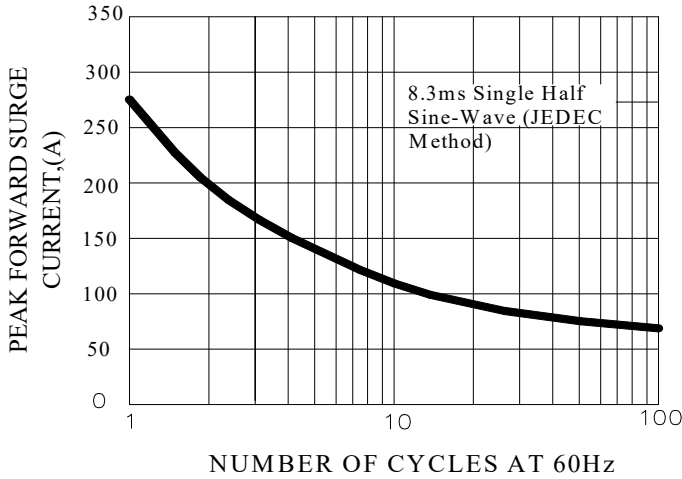

FIG.4-TYPICAL JUNCTION CAPAOTANCE

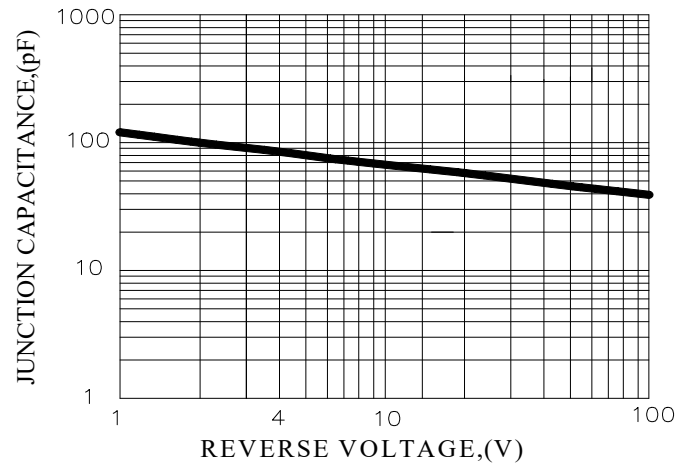
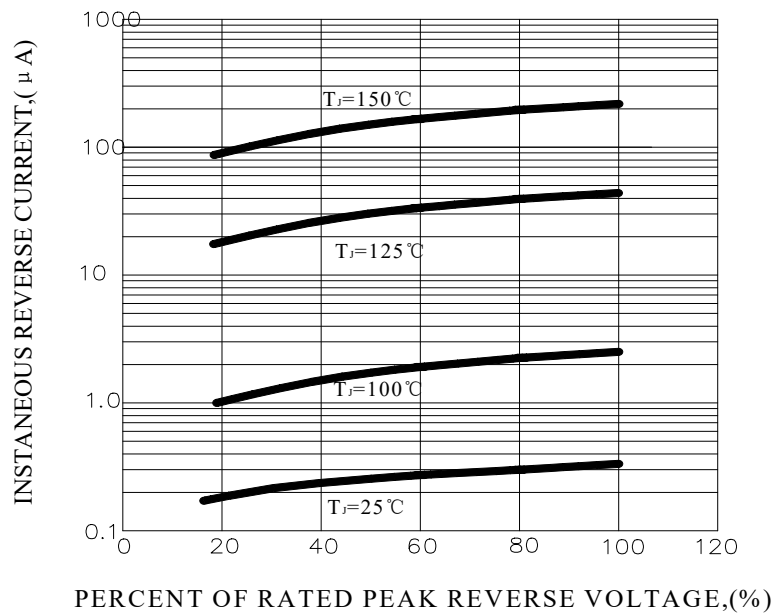
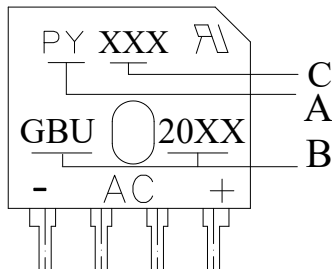

FIG.5-TYPICAL REVERSE CHARACTERISTICS



Marking and packaging illustration

1、Marking



| SYMBOL | Explanation |
|----------|--------------|
| A | Trademark |
| B | Product Name |
| C | Date code |

2、Packaging

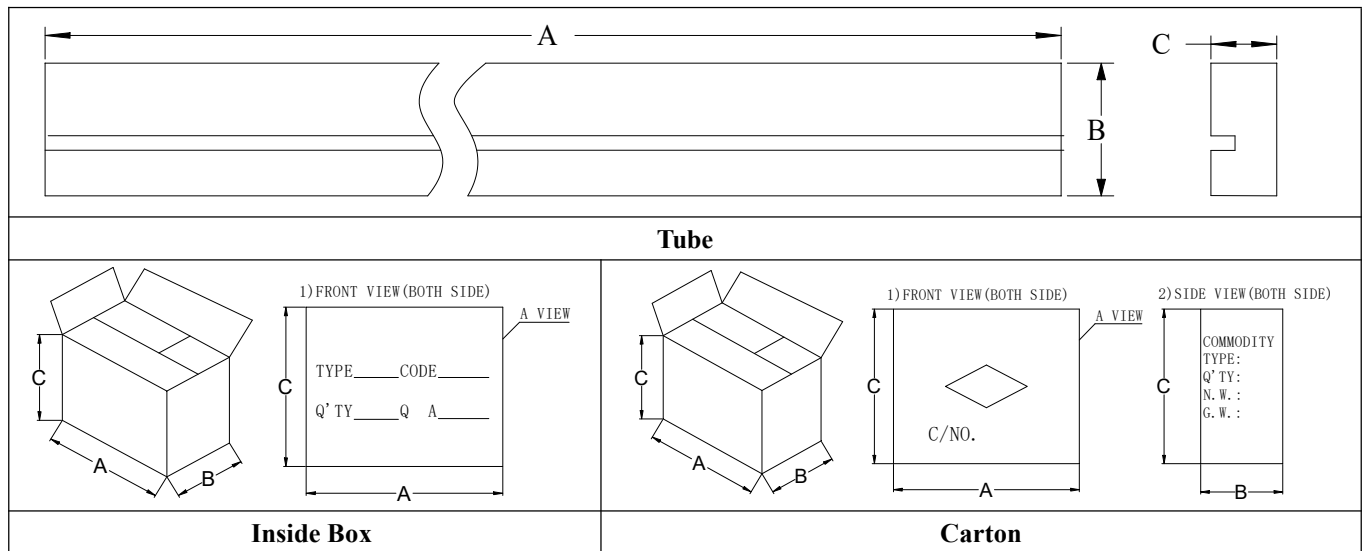

| OUTLINE | A (mm) | B (mm) | C (mm) |
|-----------|------------|-----------|--------------|
| Tube | 470±1 | 41±1 | 7.0±1 |
| Inner box | 485±3 | 130±3 | 130±3 |
| Carton | 500±5 | 285±5 | 150±5 |
| COUNT | TUBE (PCS) | BOX (PCS) | CARTON (PCS) |
| GBU | 20 | 1000 | 2000 |