

GBU1506P

SINGLE PHASE 15.0AMPS. LOW VF BRIDGE RECTIFIERS

FEATURE

- UL Listed Under Recognized Component Index, File Number E338195
- Glass passivated chip junctions
- High case dielectric strength
- Low Reverse Leakage Current
- High surge current capability
- Ideal for Printed Circuit Board Applications

MECHANICAL DATA

- Case: GBU
- Case Material: Molded Plastic.
UL Flammability Classification Rating 94V-0
- Terminals: Pure tin plated, Lead free.
Leads solderable per MIL-STD-750, Method 2026.
- Polarity: Molded on Body
- Mounting: Through Hole for #6 Screw
- Mounting Torque: 5.0 in-lbs Maximum
- Weight: 3.8 grams

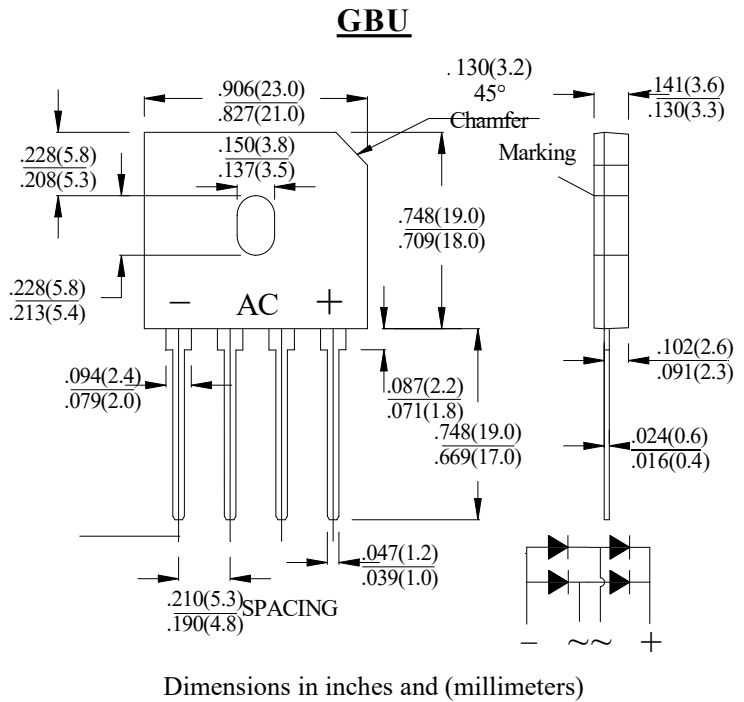

MAXIMUM RATINGS AND ELECTRICAL CHARACTERISTICS

Ratings at 25°C ambient temperature unless otherwise specified.

Single phase, half wave, 60Hz, resistive or inductive load. For capacitive load, derate current by 20%

Type Number	SYM BOL	GBU1506P	units
Maximum Recurrent Peak Reverse Voltage	V_{RRM}	600	V
Maximum RMS Voltage	V_{RMS}	420	V
Maximum DC blocking Voltage	V_{DC}	600	V
Maximum Average Forward (with heatsink Note2) Rectified Current @ $T_c=100^\circ\text{C}$ (without heatsink)	$I_{F(AV)}$	15.0 3.2	A
Peak Forward Surge Current @ $T_J=25^\circ\text{C}$ 8.3ms single half sine-wave @ $T_J=125^\circ\text{C}$	I_{FSM}	240 200	A
Peak Forward Surge Current @ $T_J=25^\circ\text{C}$ 1.0ms single half sine-wave @ $T_J=125^\circ\text{C}$	I_{FSM}	480 400	A
Maximum Forward Voltage @ 15.0A DC Drop per element @ 7.5A DC	V_F	1.0 0.9	V
Maximum DC Reverse Current @ $T_J=25^\circ\text{C}$ at rated DC blocking voltage @ $T_J=125^\circ\text{C}$	I_R	5.0 500.0	μA
I^2t Rating for Fusing ($t < 8.3\text{ms}$)	I^2t	239	A^2Sec
Typical Junction Capacitance (Note 1)	C_J	200	pF
Typical Thermal Resistance (Note 2)	$R_{(JC)}$	3.0	$^\circ\text{C}/\text{W}$
Storage Temperature	T_{STG}	-55 to +150	$^\circ\text{C}$
Operating Junction Temperature	T_J	-55 to +150	$^\circ\text{C}$

Note:

1. Measured at 1.0 MHz and applied reverse voltage of 4.0Vdc
2. Device mounted on 150mm x 150mm x 1.6mm Cu Plate Heatsink.

RATING AND CHARACTERISTIC CURVES

FIG.1-TYPICAL FORWARD CURRENT DERATING CURVE

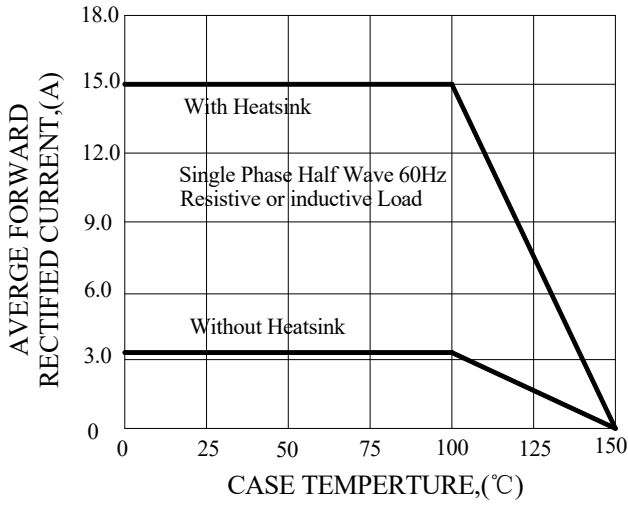

FIG.2-TYPICAL INSTANTANEOUS FORWARD CHARACTERISTICS

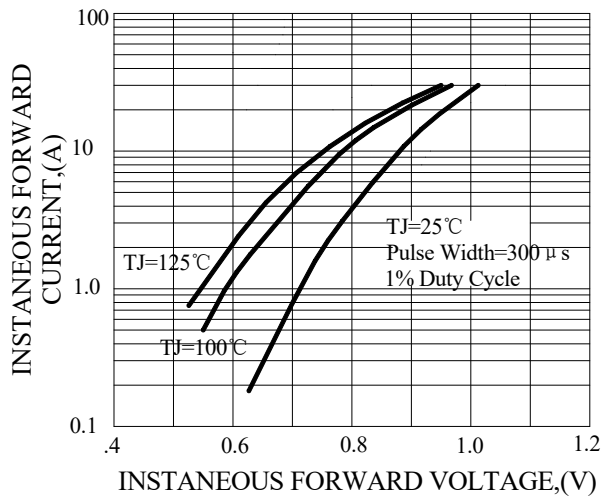

FIG.3-MAXIMUM NON-REPETITIVE FORWARD SURGE CURRENT

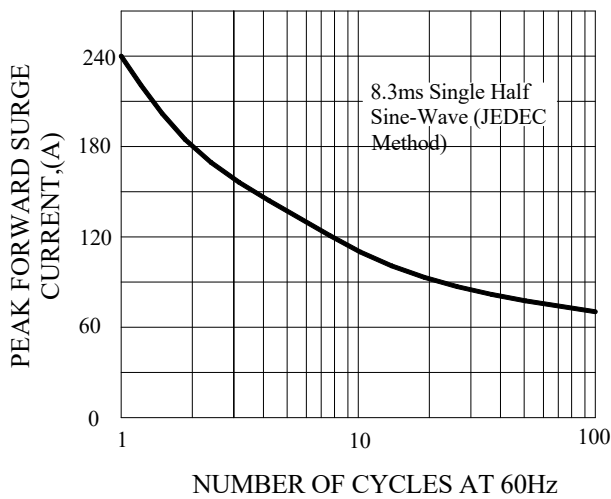

FIG.4-TYPICAL JUNCTION CAPACITANCE

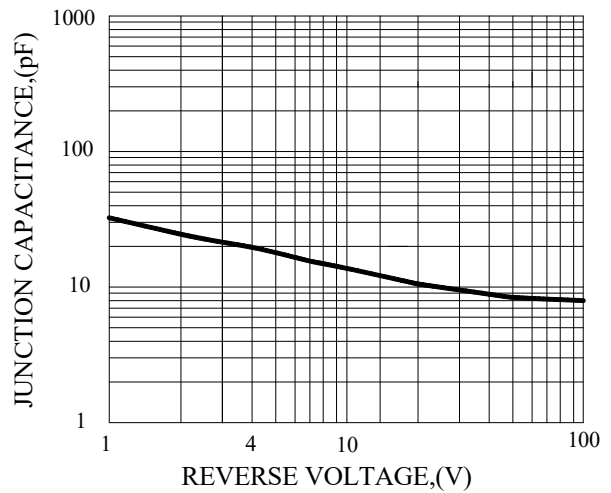
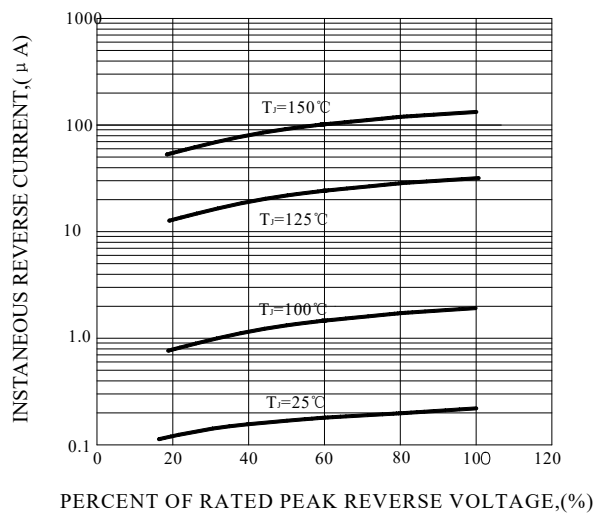
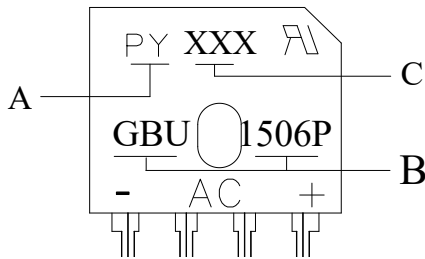

FIG.5-TYPICAL REVERSE CHARACTERISTICS



Marking and packaging illustration

1、Marking



SYMBOL	Explanation
A	Trademark
B	Product Name
C	Date code

2、Packaging

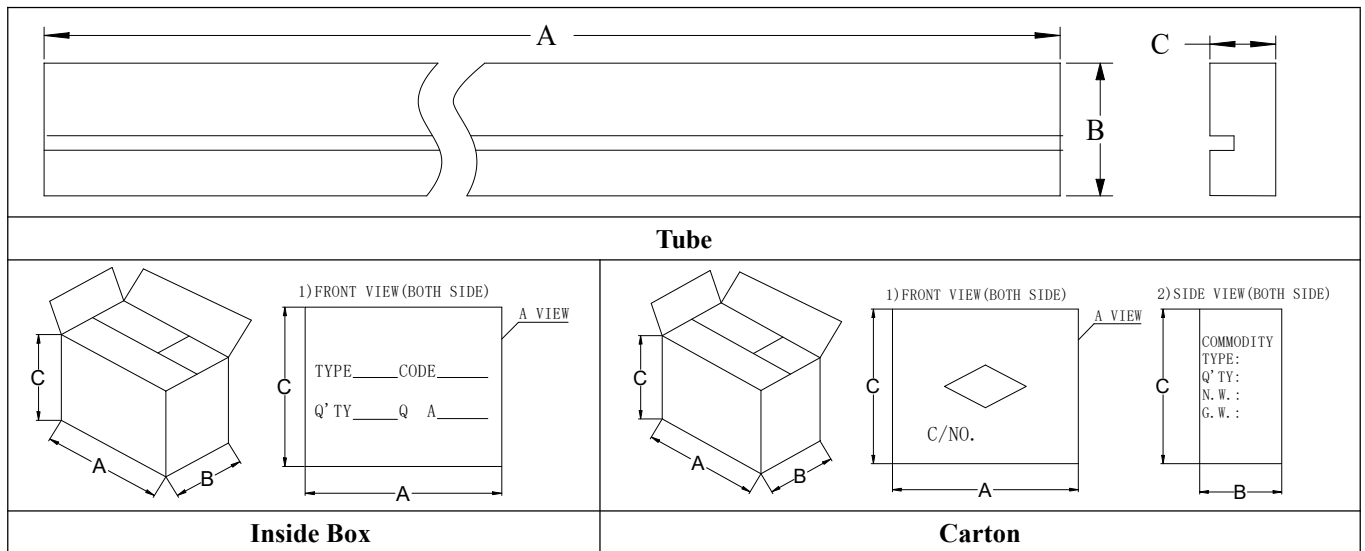

OUTLINE	A (mm)	B (mm)	C (mm)
Tube	470±1	41±1	7.0±1
Inner box	485±3	130±3	130±3
Carton	500±5	285±5	150±5

COUNT	TUBE (PCS)	BOX (PCS)	CARTON (PCS)
GBU	20	1000	2000