

## GBU2506 THRU GBU2510

### SINGLE PHASE 25.0AMPS.BRIDGE RECTIFIERS

#### FEATURE

- . UL Listed Under Recognized Component Index, File Number E338195
- . Glass passivated chip junctions
- . High case dielectric strength
- . Low Reverse Leakage Current
- . High surge current capability
- . Ideal for Printed Circuit Board Applications

#### MECHANICAL DATA

- . Case Material: Molded Plastic.
- . UL Flammability Classification Rating 94V-0
- . Terminals: Pure tin plated, Lead free.
- . Leads solderable per MIL-STD-750, Method 2026.
- . Polarity: Molded on Body
- . Mounting: Through Hole for #6 Screw
- . Mounting Torque: 5.0 in-lbs Maximum

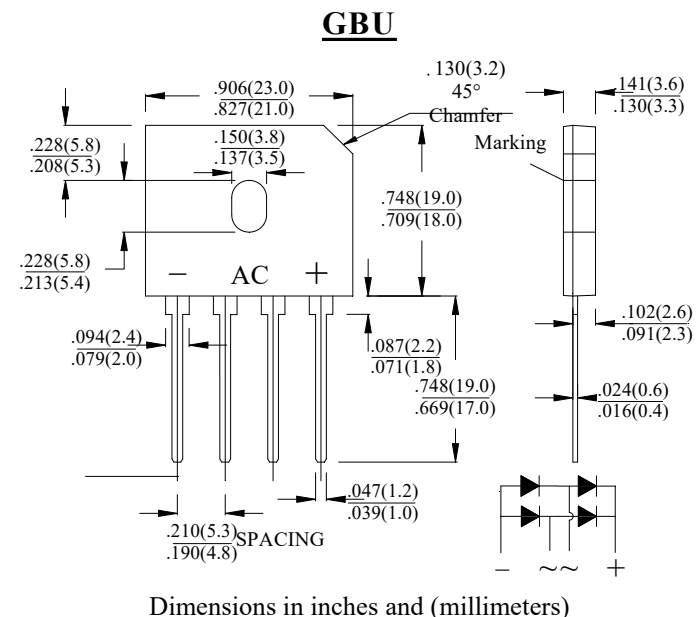

#### MAXIMUM RATINGS AND ELECTRICAL CHARACTERISTICS

Ratings at 25°C ambient temperature unless otherwise specified.

Single phase, half wave, 60Hz, resistive or inductive load. For capacitive load, derate current by 20%

| Type Number   | SYM BOL     | GBU2506 | GBU2508       | GBU2510 | units                     |
|---|-------------|---------|---------------|---------|---------------------------|
| Maximum Recurrent Peak Reverse Voltage  | $V_{RRM}$   | 600     | 800           | 1000    | V                         |
| Maximum RMS Voltage   | $V_{RMS}$   | 420     | 560           | 700     | V                         |
| Maximum DC blocking Voltage   | $V_{DC}$    | 600     | 800           | 1000    | V                         |
| Maximum Average Forward (with heatsink Note2)<br>Rectified Current @ $T_C=100^\circ\text{C}$ (without heatsink) | $I_{F(AV)}$ |         | 25.0<br>4.2   |         | A                         |
| Peak Forward Surge Current 8.3ms single half<br>sine-wave superimposed on rate load (JEDEC<br>method)           | $I_{FSM}$   |         | 300           |         | A                         |
| Maximum Forward Voltage @25.0A DC<br>Drop per element @12.5 A DC  | $V_F$       |         | 1.1<br>1.05   |         | V                         |
| Maximum DC Reverse Current @ $T_J=25^\circ\text{C}$<br>at rated DC blocking voltage @ $T_J=125^\circ\text{C}$   | $I_R$       |         | 10.0<br>500.0 |         | $\mu\text{A}$             |
| $I^2t$ Rating for Fusing ( $t < 8.3\text{ms}$ )   | $I^2t$      |         | 510           |         | $\text{A}^2\text{Sec}$    |
| Typical Junction Capacitance (Note 1)   | $C_J$       |         | 90            |         | pF                        |
| Typical Thermal Resistance (Note 2)   | $R_{(JA)}$  |         | 65            |         | $^\circ\text{C}/\text{W}$ |
|   | $R_{(JC)}$  |         | 2.2           |         |                           |
| Storage Temperature   | $T_{STG}$   |         | -55 to +150   |         | $^\circ\text{C}$          |
| Operating Junction Temperature  | $T_J$       |         | -55 to +150   |         | $^\circ\text{C}$          |

#### Note:

1. Measured at 1.0 MHz and applied reverse voltage of 4.0Vdc
2. Device mounted on 250mm x 250mm x 2.0mm Aluminum Plate Heatsink.

**RATING AND CHARACTERISTIC CURVES**

FIG.1-TYPICAL FORWARD CURRENT DERATING CURVE

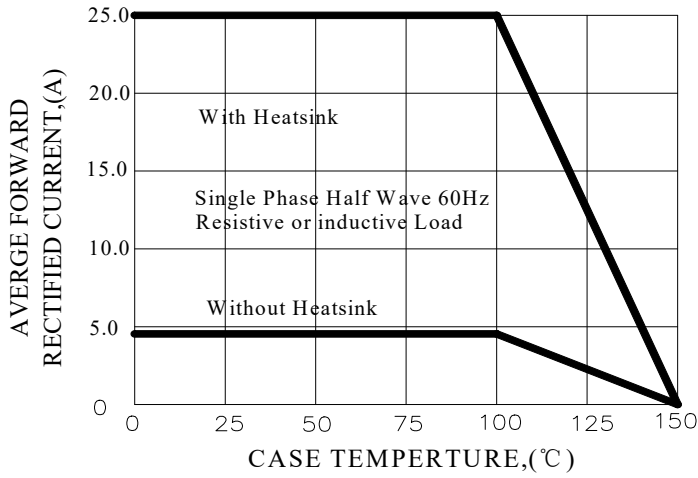

FIG.2-TYPICAL INSTANTANEOUS FORWARD CHARACTERISTICS

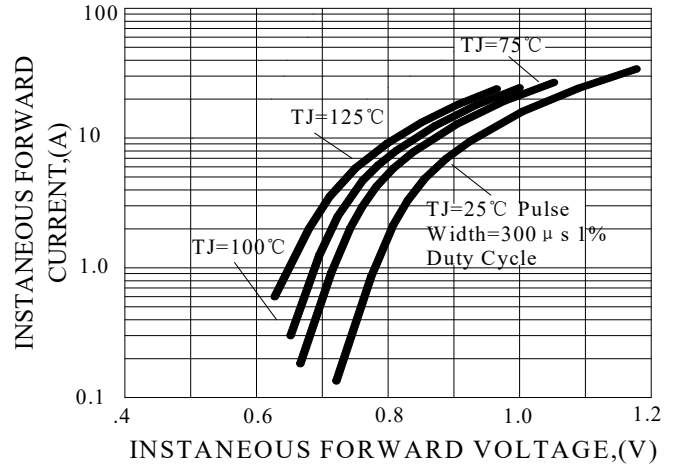

FIG.3-MAXIMUN NON-REPETITIVE FORWARD SURGE CURRENT

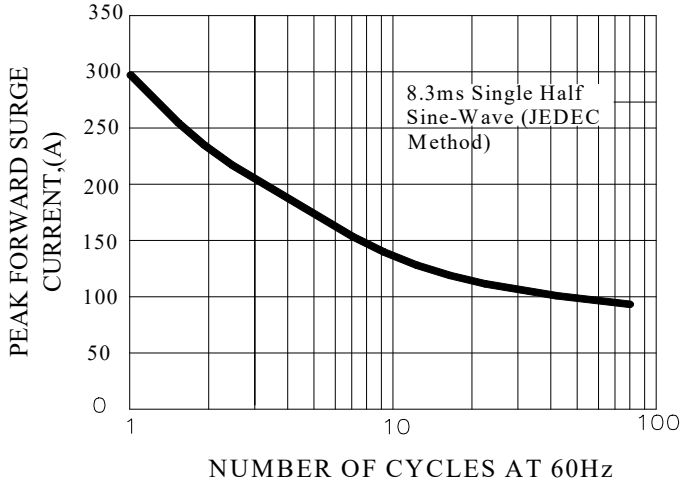

FIG.4-TYPICAL JUNCTION CAPAOTANCE

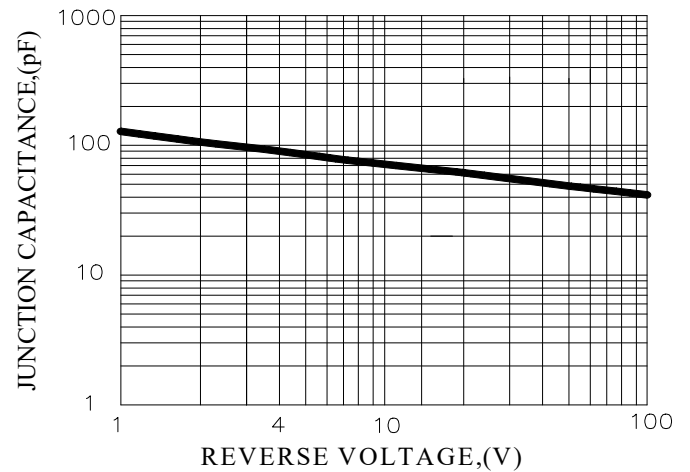
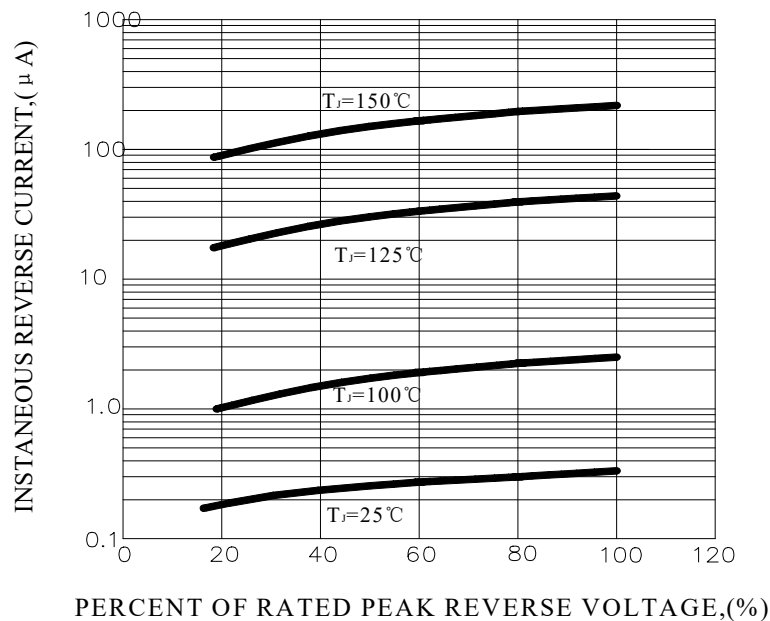
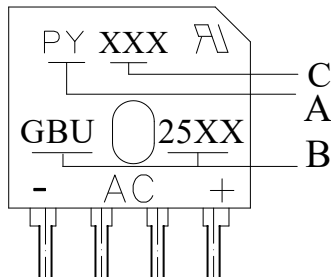

FIG.5-TYPICAL REVERSE CHARACTERISTICS



## Marking and packaging illustration

### 1、Marking



| SYMBOL   | Explanation  |
|----------|--------------|
| <b>A</b> | Trademark    |
| <b>B</b> | Product Name |
| <b>C</b> | Date code    |

### 2、Packaging

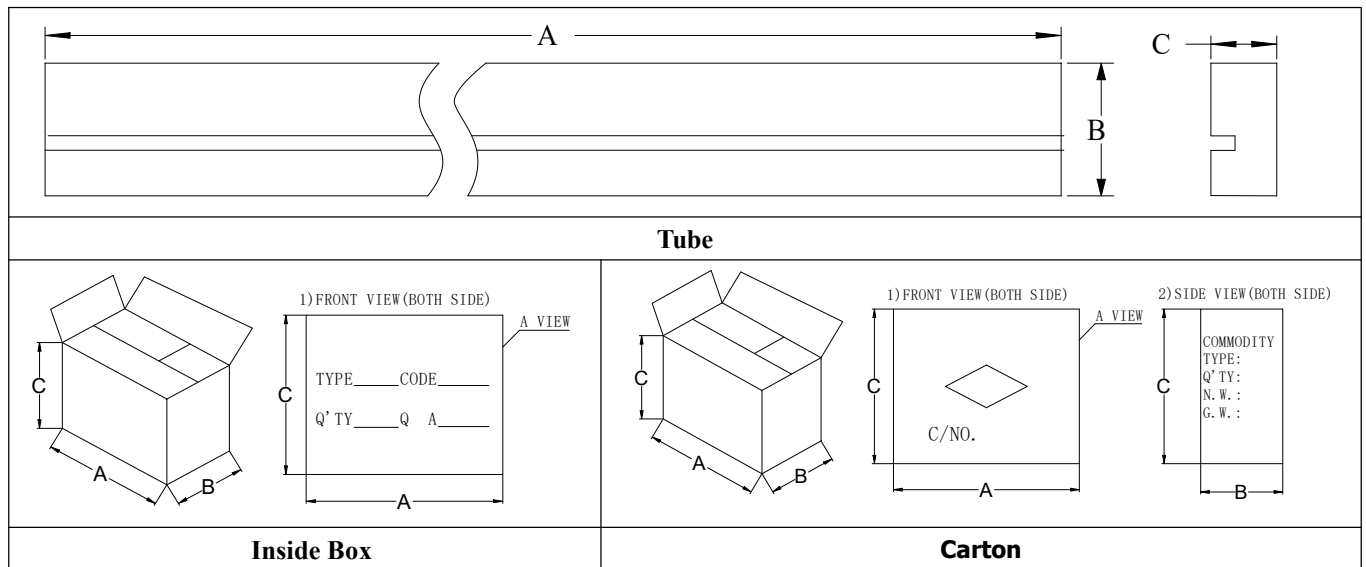

| OUTLINE   | A (mm) | B (mm) | C (mm) |
|-----------|--------|--------|--------|
| Tube      | 470±1  | 41±1   | 7.0±1  |
| Inner box | 485±3  | 130±3  | 130±3  |
| Carton    | 500±5  | 285±5  | 150±5  |

| COUNT | TUBE (PCS) | BOX (PCS) | CARTON (PCS) |
|-------|------------|-----------|--------------|
| GBU   | 20         | 1000      | 2000         |