

GBU406 THRU GBU410

SINGLE PHASE 4.0AMPS. GLASS PASSIVATED BRIDGE RECTIFIERS

FEATURE

- . UL Listed Under Recognized Component Index, File Number E338195
- . High case dielectric strength
- . Low Reverse Leakage Current
- . High surge current capability
- . Ideal for Printed Circuit Board Applications

MECHANICAL DATA

- . Case: GBU
- . Case Material: Molded Plastic.
UL Flammability Classification Rating 94V-0
- . Terminals: Pure tin plated, Lead free.
Leads solderable per MIL-STD-750, Method 2026.
- . Polarity: Molded on Body
- . Mounting: Through Hole for #6 Screw
- . Mounting Torque: 5.0 in-lbs Maximum

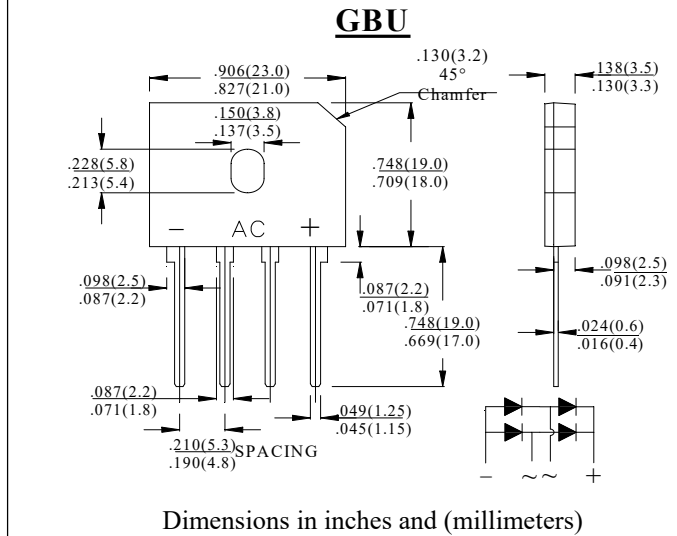

MAXIMUM RATINGS AND ELECTRICAL CHARACTERISTICS

Ratings at 25°C ambient temperature unless otherwise specified.

Single phase, half wave, 60Hz, resistive or inductive load. For capacitive load, derate current by 20%

Type Number	SYM BOL	GBU406	GBU408	GBU410	units
Maximum Recurrent Peak Reverse Voltage	V_{RRM}	600	800	1000	V
Maximum RMS Voltage	V_{RMS}	420	560	700	V
Maximum DC blocking Voltage	V_{DC}	600	800	1000	V
Maximum Average Forward (with heatsink Note2) Rectified Current @ $T_C=100^\circ\text{C}$ (without heatsink)	$I_{F(AV)}$		4.0 2.4		A
Peak Forward Surge Current 8.3ms single half sine-wave superimposed on rate load (JEDEC method)	I_{FSM}		150		A
Maximum Forward Voltage @ 4.0A DC Drop per element @ 2.0A DC	V_F		1.1 1.0		V
Maximum DC Reverse Current @ $T_J=25^\circ\text{C}$ at rated DC blocking voltage @ $T_J=125^\circ\text{C}$	I_R		5.0 500.0		μA
I^2t Rating for Fusing ($t < 8.3\text{ms}$)	I^2t		93		A^2Sec
Typical Junction Capacitance (Note 1)	C_J		40		pF
Typical Thermal Resistance (Note 2)	$R_{(JC)}$		3.0		$^\circ\text{C}/\text{W}$
Storage Temperature	T_{STG}		-55 to +150		$^\circ\text{C}$
Operating Junction Temperature	T_J		-55 to +150		$^\circ\text{C}$

Note:

1. Measured at 1.0 MHz and applied reverse voltage of 4.0Vdc
2. Device mounted on 75mm x 75mm x 1.6mm Cu Plate Heatsink.

RATING AND CHARACTERISTIC CURVES

FIG.1-TYPICAL FORWARD CURRENT DERATING CURVE

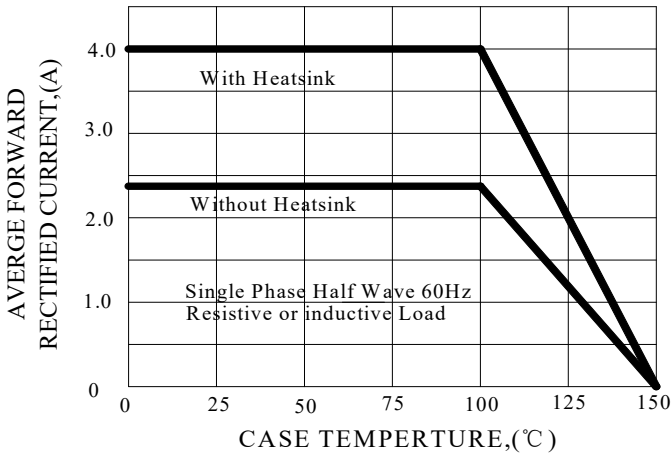

FIG.2-TYPICAL INSTANTANEOUS FORWARD CHARACTERISTICS

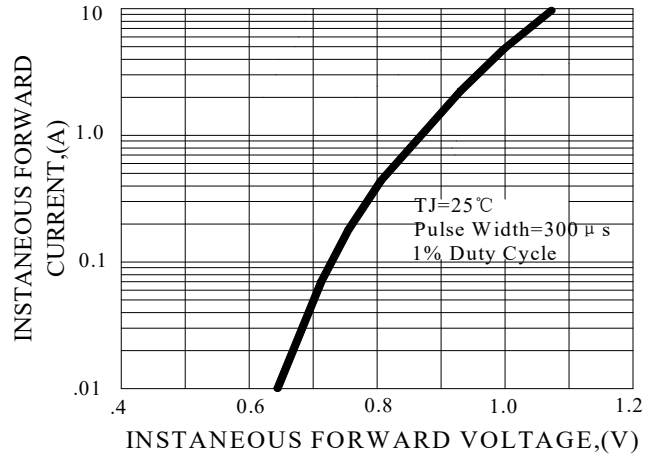

FIG.3-MAXIMUN NON-REPETITIVE FORWARD SURGE CURRENT

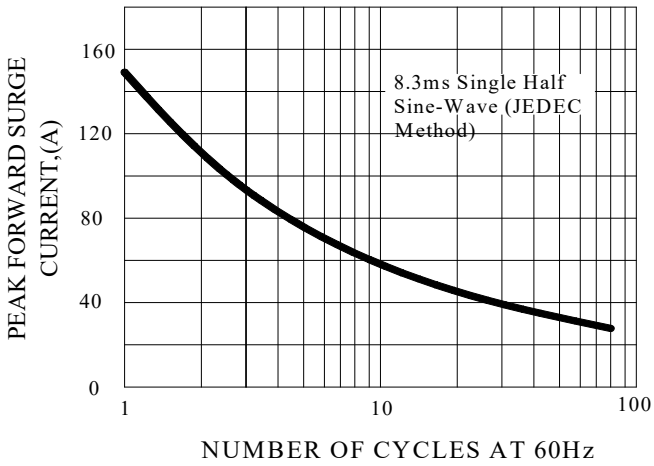

FIG.4-TYPICAL JUNCTION CAPAOTANCE

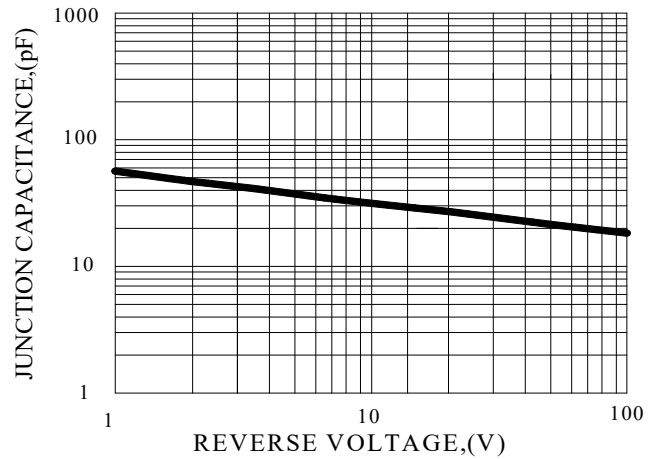
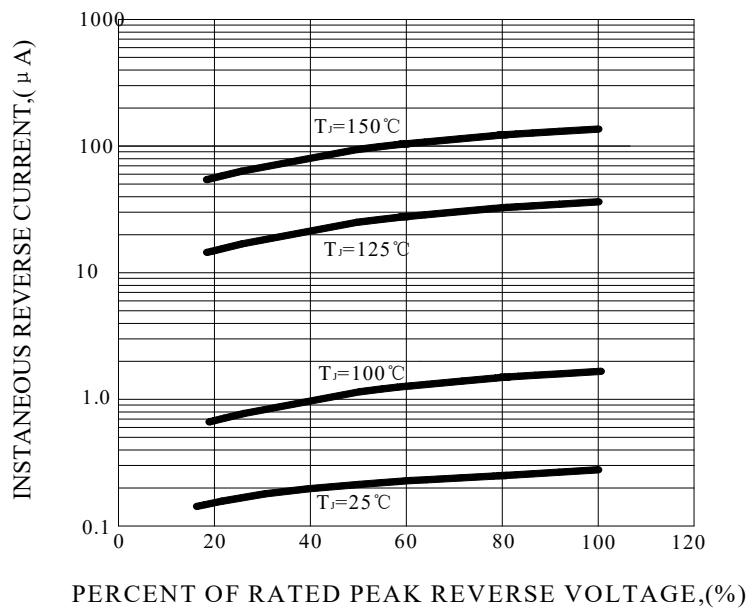
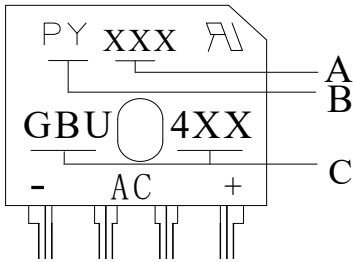

FIG.5-TYPICAL REVERSE CHARACTERISTICS



Marking and packaging illustration

1、Marking



SYMBOL	Explanation
A	Date code
B	Trademark
C	Product Name

2、Packaging

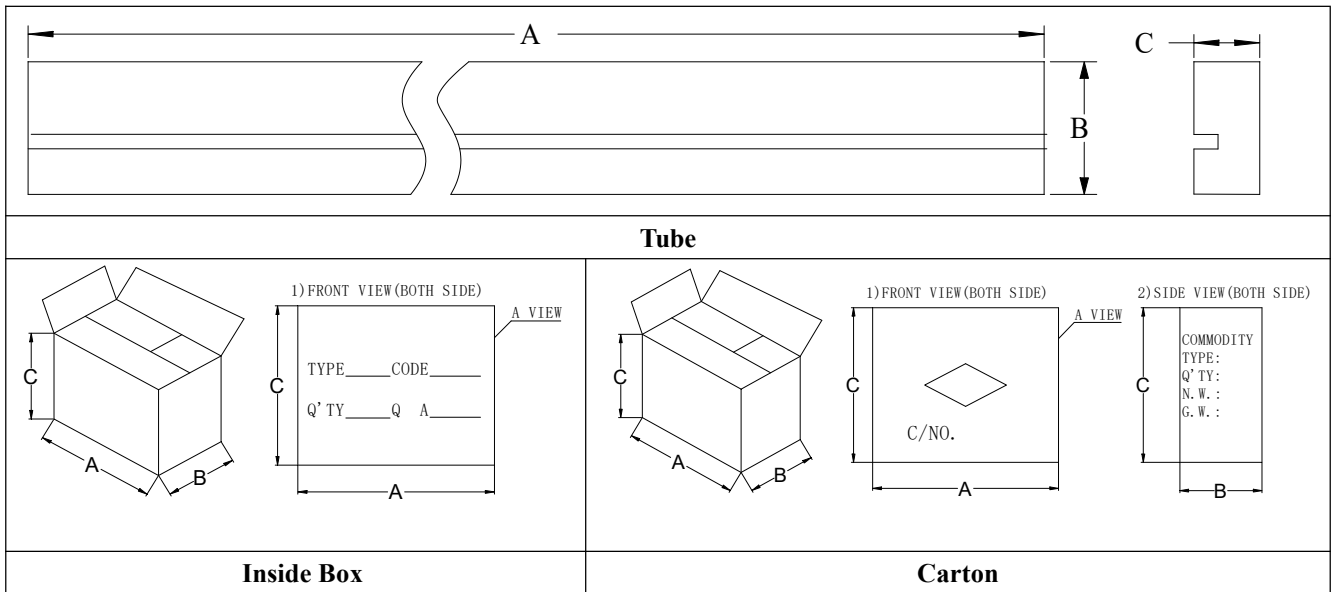

OUTLINE	A (mm)	B (mm)	C (mm)
Tube	470±1	41±1	7.0±1
Inner box	475±3	125±3	95±3
Carton	480±5	260±5	200±5
COUNT	TUBE	BOX	CARTON
	(PCS)	(PCS)	(PCS)
GBU	20	400	2000