

## GBU1506 THRU GBU1510

### SINGLE PHASE 15.0AMPS.GLASS PASSIVATED BRIDGE RECTIFIERS

#### FEATURE

- . UL Listed Under Recognized Component Index, File Number E338195
- . High case dielectric strength
- . Low Reverse Leakage Current
- . High surge current capability
- . Ideal for Printed Circuit Board Applications

#### MECHANICAL DATA

- . Case Material: Molded Plastic.
- . UL Flammability Classification Rating 94V-0
- . Terminals: Pure tin plated, Lead free.
- . Leads solderable per MIL-STD-750, Method 2026.
- . Polarity: Molded on Body
- . Mounting: Through Hole for #6 Screw
- . Mounting Torque: 5.0 in-lbs Maximum
- . RoHS 2.0 Compliant
- . Halogen free

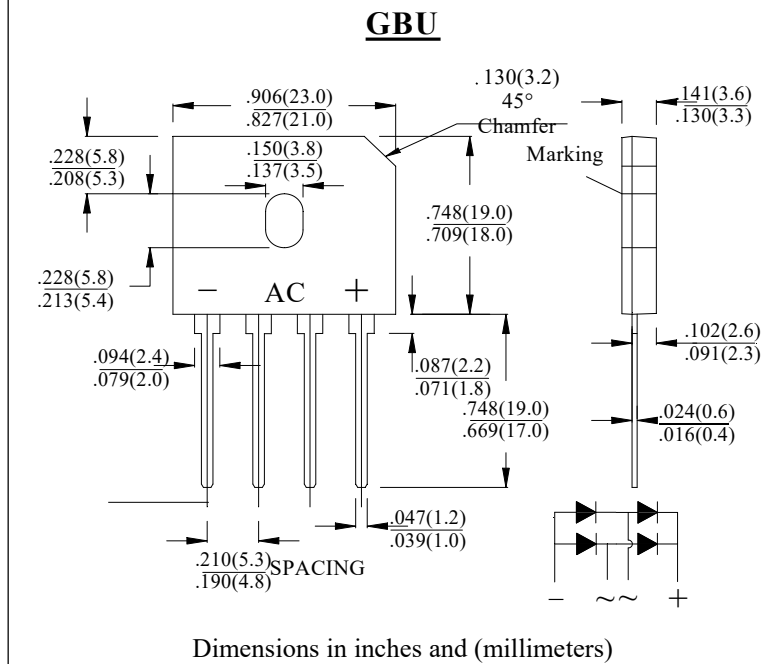

#### MAXIMUM RATINGS AND ELECTRICAL CHARACTERISTICS

Ratings at 25°C ambient temperature unless otherwise specified.

Single phase, half wave, 60Hz, resistive or inductive load. For capacitive load, derate current by 20%

| Type Number  | SYM BOL     | GBU1506 | GBU1508      | GBU1510 | units              |
|--|-------------|---------|--------------|---------|--------------------|
| Maximum Recurrent Peak Reverse Voltage   | $V_{RRM}$   | 600     | 800          | 1000    | V                  |
| Maximum RMS Voltage  | $V_{RMS}$   | 420     | 560          | 700     | V                  |
| Maximum DC blocking Voltage  | $V_{DC}$    | 600     | 800          | 1000    | V                  |
| Maximum Average Forward (with heatsink Note2)<br>Rectified Current @ $T_C=100^{\circ}C$ (without heatsink) | $I_{F(AV)}$ |         | 15.0<br>3.2  |         | A                  |
| Peak Forward Surge Current 8.3ms single half<br>sine-wave superimposed on rate load (JEDEC<br>method)      | $I_{FSM}$   |         | 240          |         | A                  |
| Maximum Forward Voltage @15A DC<br>Drop per element @7.5A DC   | $V_F$       |         | 1.1<br>1.05  |         | V                  |
| Maximum DC Reverse Current @ $T_J=25^{\circ}C$<br>at rated DC blocking voltage @ $T_J=125^{\circ}C$        | $I_R$       |         | 5.0<br>500.0 |         | $\mu A$            |
| $I^2t$ Rating for Fusing ( $t < 8.3ms$ )   | $I^2t$      |         | 239          |         | A <sup>2</sup> Sec |
| Typical Junction Capacitance (Note 1)  | $C_J$       |         | 80           |         | pF                 |
| Typical Thermal Resistance (Note 2)  | $R_{(JA)}$  |         | 22           |         | $^{\circ}C/W$      |
|  | $R_{(JC)}$  |         | 2.2          |         |                    |
| Storage Temperature  | $T_{STG}$   |         | -55 to +150  |         | $^{\circ}C$        |
| Operating Junction Temperature   | $T_J$       |         | -55 to +150  |         | $^{\circ}C$        |

**Note:** 1. Measured at 1.0 MHz and applied reverse voltage of 4.0Vdc

2. Device mounted on 150mm x 150mm x 1.6mm Cu Plate Heatsink.

RATING AND CHARACTERISTIC CURVES

FIG.1-TYPICAL FORWARD CURRENT DERATING CURVE

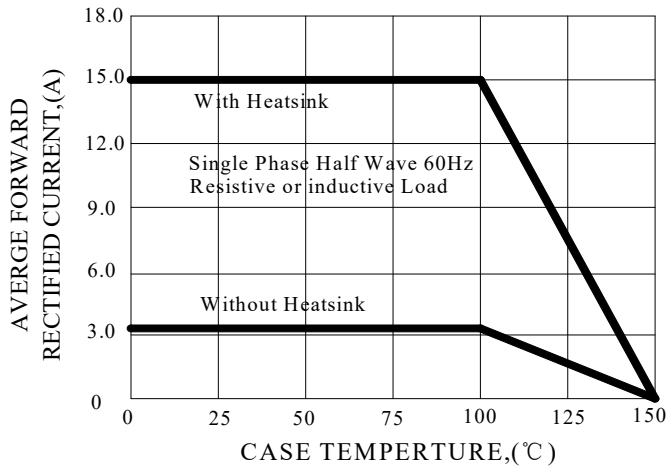

FIG.2-TYPICAL INSTANTANEOUS FORWARD CHARACTERISTICS

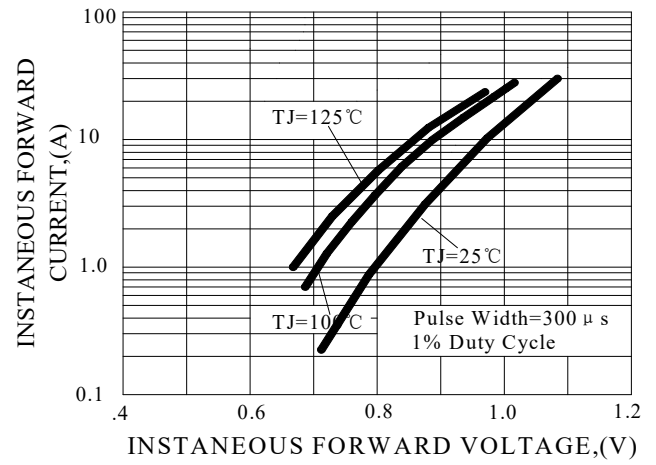

FIG.3-MAXIMUN NON-REPETITIVE FORWARD SURGE CURRENT

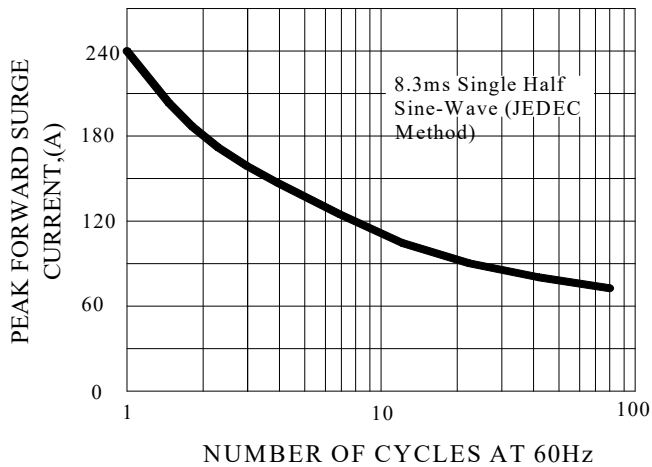

FIG.4-TYPICAL JUNCTION CAPAOTANCE

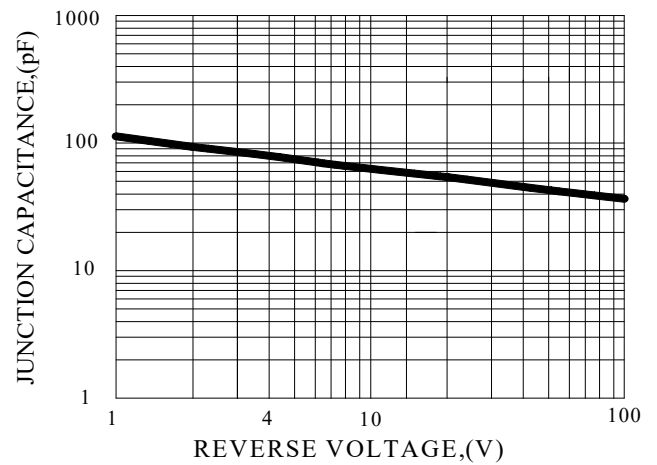
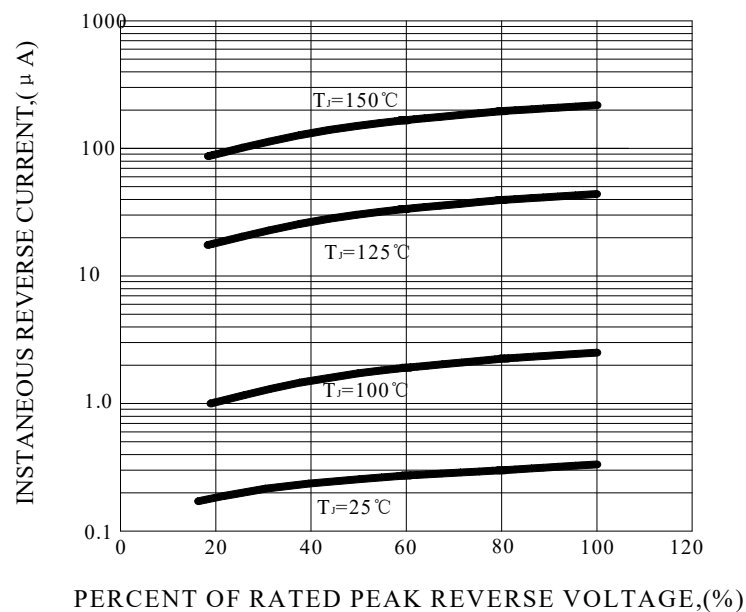
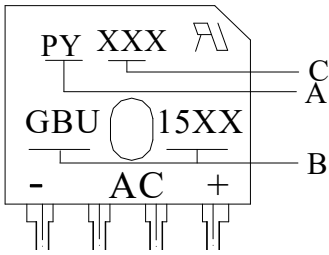

FIG.5-TYPICAL REVERSE CHARACTERISTICS



## Marking and packaging illustration

### 1、Marking



| SYMBOL   | Explanation  |
|----------|--------------|
| <b>A</b> | Trademark    |
| <b>B</b> | Product Name |
| <b>C</b> | Date code    |

### 2、Packaging

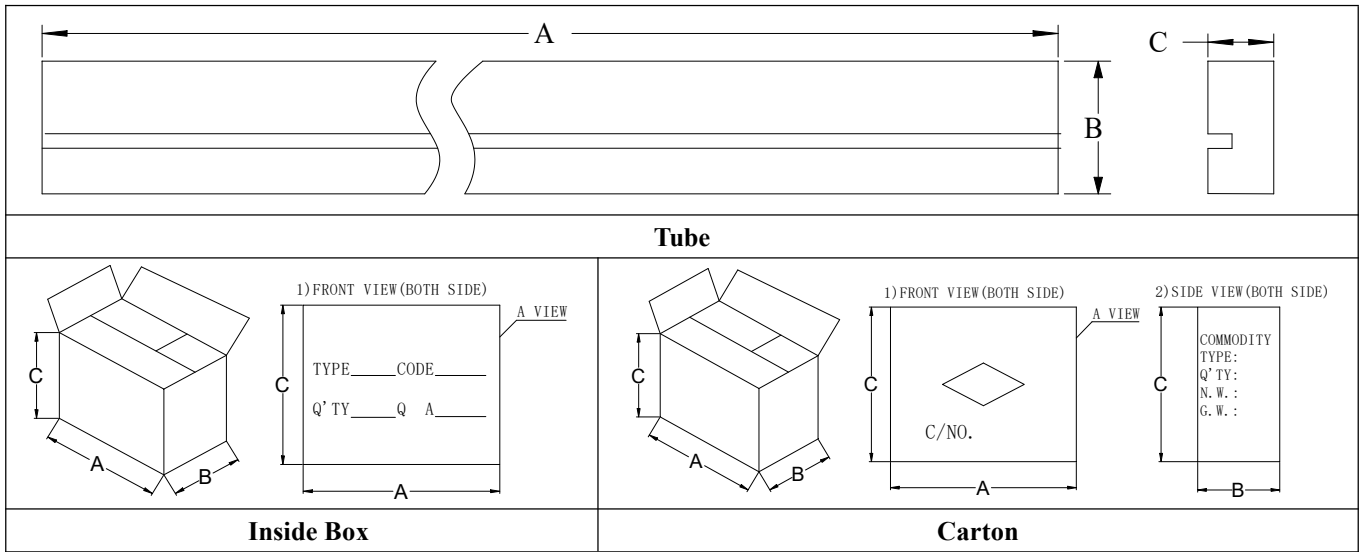

| OUTLINE   | A (mm)     | B (mm)    | C (mm)       |
|-----------|------------|-----------|--------------|
| Tube      | 470±1      | 41±1      | 7.0±1        |
| Inner box | 485±3      | 130±3     | 130±3        |
| Carton    | 500±5      | 285±5     | 150±5        |
| COUNT     | TUBE (PCS) | BOX (PCS) | CARTON (PCS) |
| GBU       | 20         | 1000      | 2000         |