

ES2DG THRU ES2JG

2.0AMPS. SUPER FAST SURFACE MOUNT RECTIFIER

FEATURE

- . High current capability
- . Low forward voltage drop
- . Low power loss, high efficiency
- . High surge capability
- . High temperature soldering guaranteed:
260°C/10 seconds at terminals.
- . Superfast recovery time for high efficiency.
- . For surface mounted application.

MECHANICAL DATA

- . Case: Molded plastic
- . Epoxy: UL94V-0 rate flame retardant
- . Lead: MIL-STD- 202E, Method 208 guaranteed
- . Polarity:Color band denotes cathode end
- . Packaging: 12mm tape per EIA STD RS-481
- . Mounting position: Any

SMB (DO-214AA)

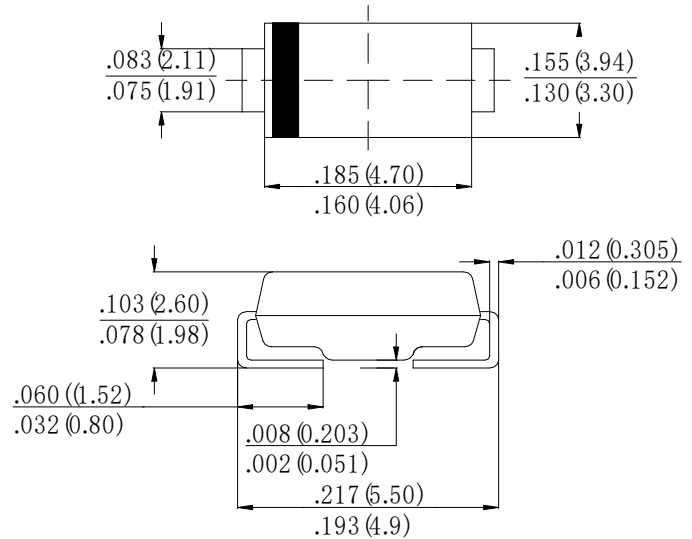

Dimensions in inches and (millimeters)

MAXIMUM RATINGS AND ELECTRICAL CHARACTERISTICS

Ratings at 25°C ambient temperature unless otherwise specified.

Single phase, half wave, 60Hz, resistive or inductive load. For capacitive load, derate current by 20%

Type Number	SYM BOL	ES2DG	ES2GG	ES2JG	units
Maximum Recurrent Peak Reverse Voltage	V_{RRM}	200	400	600	V
Maximum RMS Voltage	V_{RMS}	140	280	420	V
Maximum DC blocking Voltage	V_{DC}	200	400	600	V
Maximum Average Forward Rectified Current	$I_{F(AV)}$	2.0			A
Peak Forward Surge Current 8.3ms single half sine- wave superimposed on rated load (JEDEC method)	I_{FSM}	50.0			A
Maximum Forward Voltage at 2.0A DC	V_F	0.95	1.3	1.7	V
Maximum DC Reverse Current @ $T_J=25^\circ\text{C}$ at rated DC blocking voltage @ $T_J=125^\circ\text{C}$	I_R	5.0 200.0			μA
Maximum Reverse Recovery Time (Note 1)	t_{rr}	35			nS
Typical Junction Capacitance (Note 2)	C_J	18		12	pF
Typical Thermal Resistance (Note 3)	$R_{(JA)}$ $R_{(JC)}$	55 25			$^\circ\text{C}/\text{W}$
Storage Temperature	T_{STG}	-55 to +150			$^\circ\text{C}$
Operation Junction Temperature	T_J	-55 to +150			$^\circ\text{C}$

Note:

1. Test Conditions: $I_F=0.5\text{A}$, $I_R=1.0\text{A}$, $I_{RR}=0.25\text{A}$
2. Measured at 1.0 MHz and applied reverse voltage of 4.0Vdc
3. Measured on P.C.Board with 15.0×15.0mm Copper Pad Areas.

RATING AND CHARACTERISTIC CURVES

FIG.1-TYPICAL FORWARD CURRENT DERATING CURVE

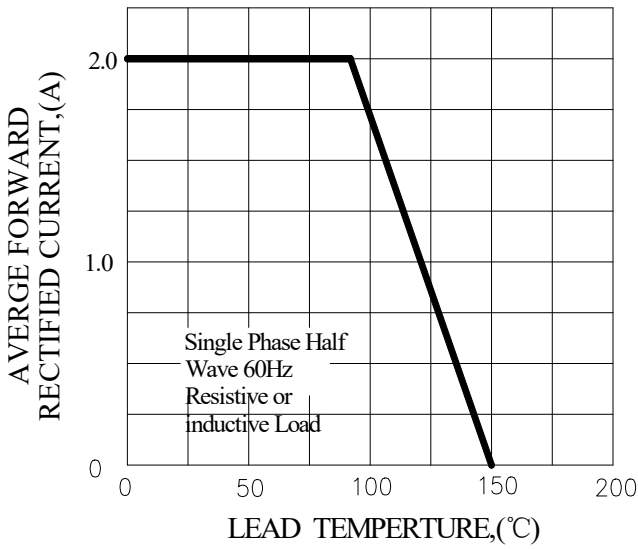

FIG.2-TYPICAL INSTANTANEOUS FORWARD CHARACTERISTICS

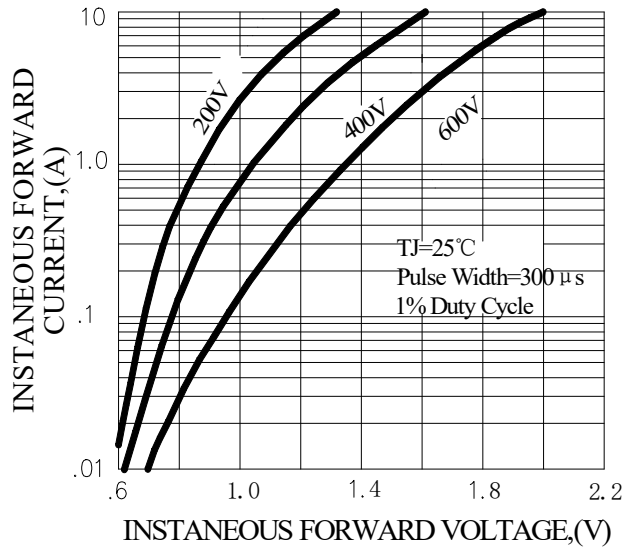

FIG.3-MAXIMUM NON-REPETITIVE FORWARD SURGE CURRENT

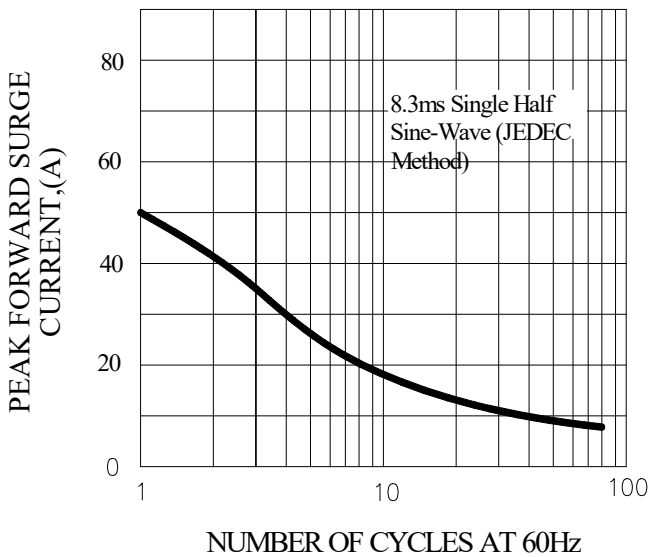

FIG.4-TYPICAL REVERSE CHARACTERISTICS

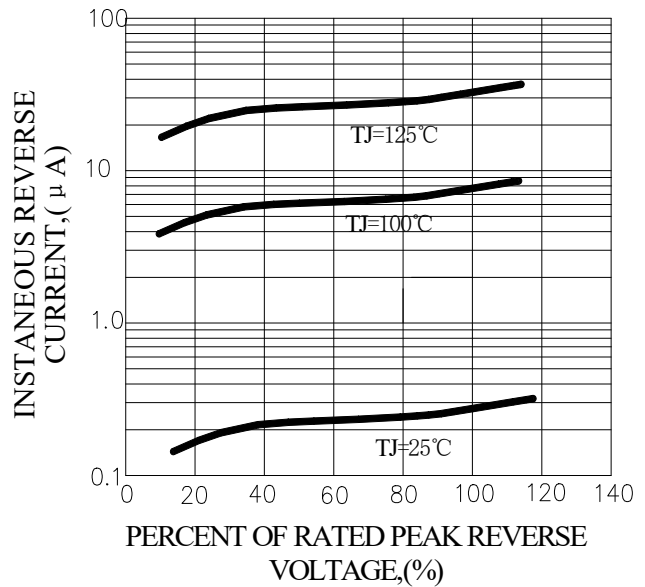
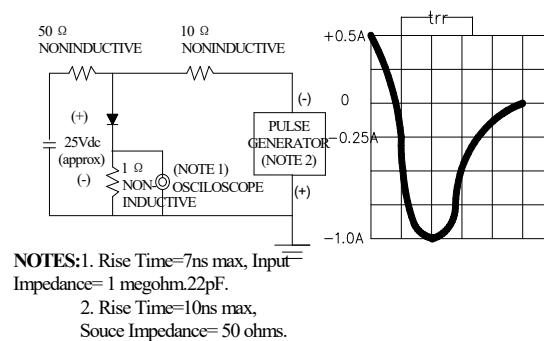
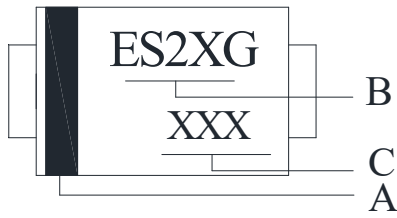

FIG.5-TEST CIRCUIT DIAGRAM AND REVERSE RECOVERY TIME CHARACTERISTIC



Marking and packaging illustration

1、Marking



SYMBOL	explanation
A	Color Band Denotes Cathode
B	Product name
C	Date code

2、Packaging

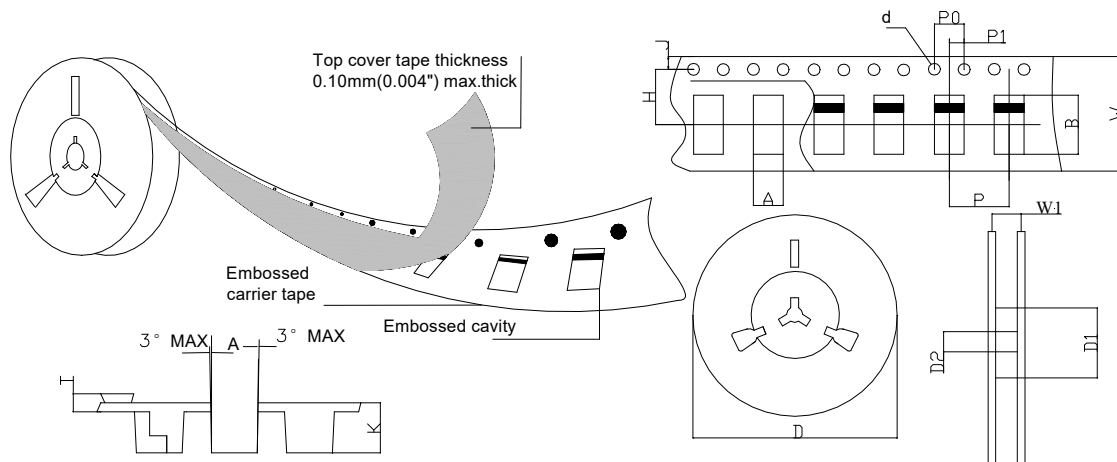

SPECIFICATIONS mm(inch)		PACKAGE	SPECIFICATIONS mm(inch)		PACKAGE
ITEM	SYM BOL	SMB (DO-214AA)	ITEM	SYM BOL	SMB (DO-214AA)
Carrier width	A	3.81(0.150)Max	Carrier depth	K	2.45(0.965)Typ
Carrier length	B	5.41(0.213)Max	Punch hole pitch	P	8.00(0.315)Typ
Sprocket hole	d	ø1.55(0.061)Typ	Sprocket hole pitch	P0	4.00(0.157)Typ
Reel outer diameter	D	330.0(13.0)Typ	Embossment center	P1	2.00(0.079)Typ
Reel inner diameter	D1	50.0(1.969)Min	Overall tape thickness	T	0.30(0.012)Typ
Feed hole diameter	D2	13.0(0.512)Typ	Tape width	W	12.0(0.472)Typ
Sprocket hole position	J	1.75(0.069)Typ	Reel width	W1	12.4(0.488)Min
Punch hole position	H	5.55(0.219)Typ			