

HBR60200YCT

60.0AMPS. SCHOTTKY BARRIER RECTIFIERS

FEATURE

- .High current capability
- .Low forward voltage drop
- .Low power loss, high efficiency
- .High surge capability
- .High temperature soldering guaranteed
260°C /10seconds, 0.25"(6.35mm)from case.

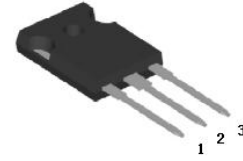

TO-247-3L
HBR60200YCT

MECHANICAL DATA

- .Case: Molded with UL-94 Class V-0 recognized
Flame Retardant Epoxy
- .Mounting position: any

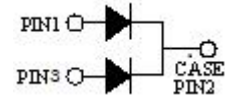

Single phase, half wave, 60Hz,resistive or inductive load.

For capacitive load, derate current by 20%

MAXIMUM RATINGS (T_C=25°C unless otherwise noted)

Parameter	Symbol	HBR60200YCT	Units
Maximum Recurrent Peak Reverse Voltage	V_{RRM}	200	V
Maximum RMS Voltage	V_{RMS}	140	V
Maximum DC blocking Voltage	V_{DC}	200	V
Maximum Average Forward Rectified Current <i>Per Leg</i> at T _C =100°C <i>Total device</i>	$I_{F(AV)}$	30.0 60.0	A
Peak Forward Surge Current 8.3ms single half sine-wave superimposed on rated load (JEDEC method) <i>Per Leg</i>	I_{FSM}	300.0	A
Typical Junction Capacitance (Note 1)	C_J	325	pF
Operation Junction Temperature and Storage Temperature	T_J, T_{STG}	-55 to +175	°C

ELECTRICAL CHARACTERISTICS-(per leg) (T_A=25°C unless otherwise noted)

Parameter	Symbol	Test conditions	Typ	Max	Units	
Forward voltage drop	V_F	T _J =25°C	I _F =5A	0.72	---	V
			I _F =10A	0.77	---	
			I _F =30A	0.90	0.95	
		T _J =125°C	I _F =5A	0.55	---	
			I _F =10A	0.61	---	
			I _F =30A	0.75	0.80	
Reverse leakage current	I_R	T _J =25°C	V _R =200V	---	20	μA
		T _J =125°C	V _R =200V	---	5	mA

THERMAL CHARACTERISTICS(T_C=25°C unless otherwise noted)

Parameter	Symbol	HBR60200YCT	Units
Typical Thermal Resistance (Note 2)	$R_{(JC)}$	0.5	°C/W

Notes:

1. Measured at 1.0 MHz and applied reverse voltage of 4.0Vdc
2. Thermal Resistance from Junction to Case

RATING AND CHARACTERISTIC CURVES

FIG.1-TYPICAL FORWARD CURRENT DERATING CURVE

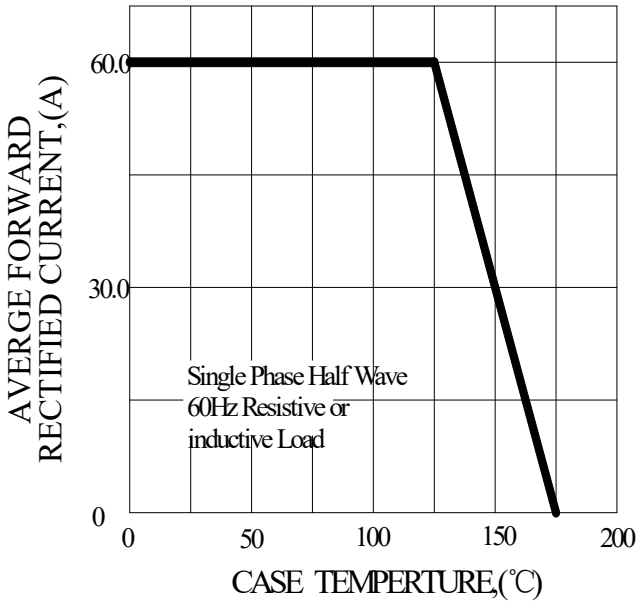

FIG.2-TYPICAL INSTANTANEOUS FORWARD CHARACTERISTICS

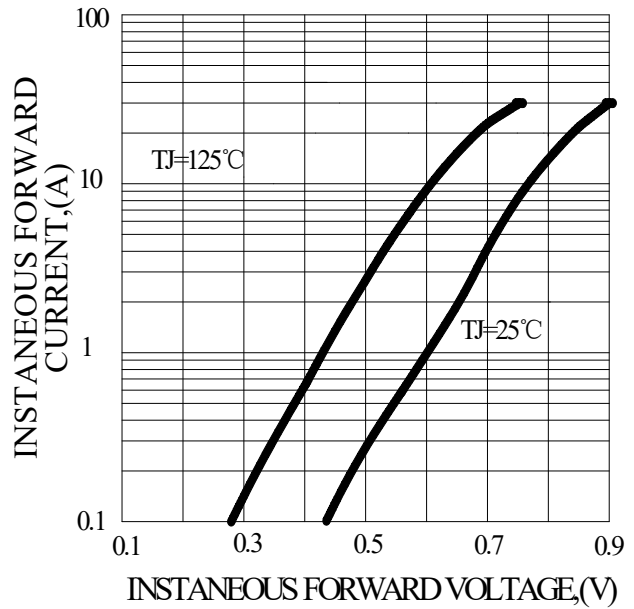

FIG.3-MAXIMUM NON-REPETITIVE FORWARD SURGE CURRENT

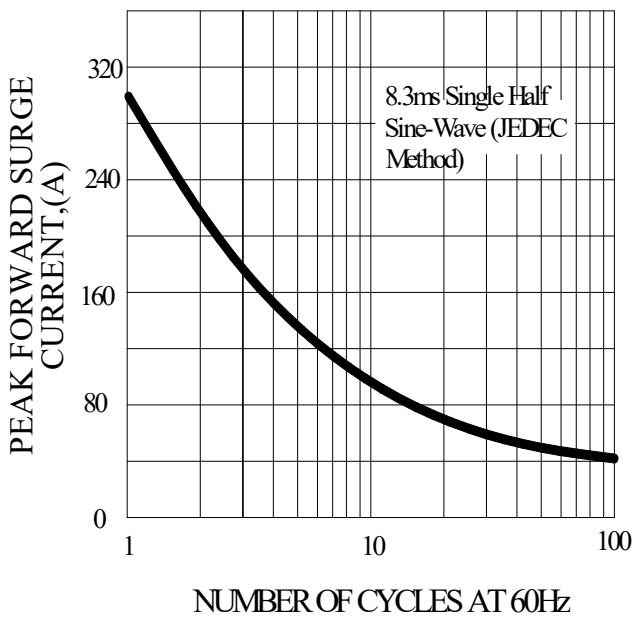
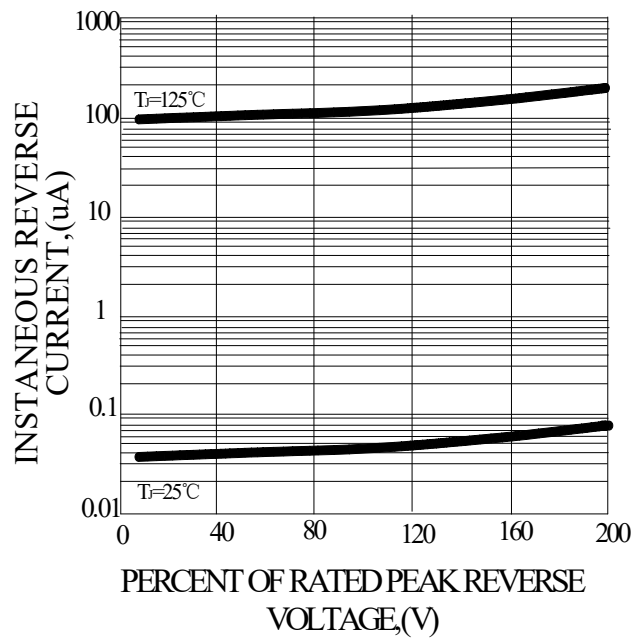
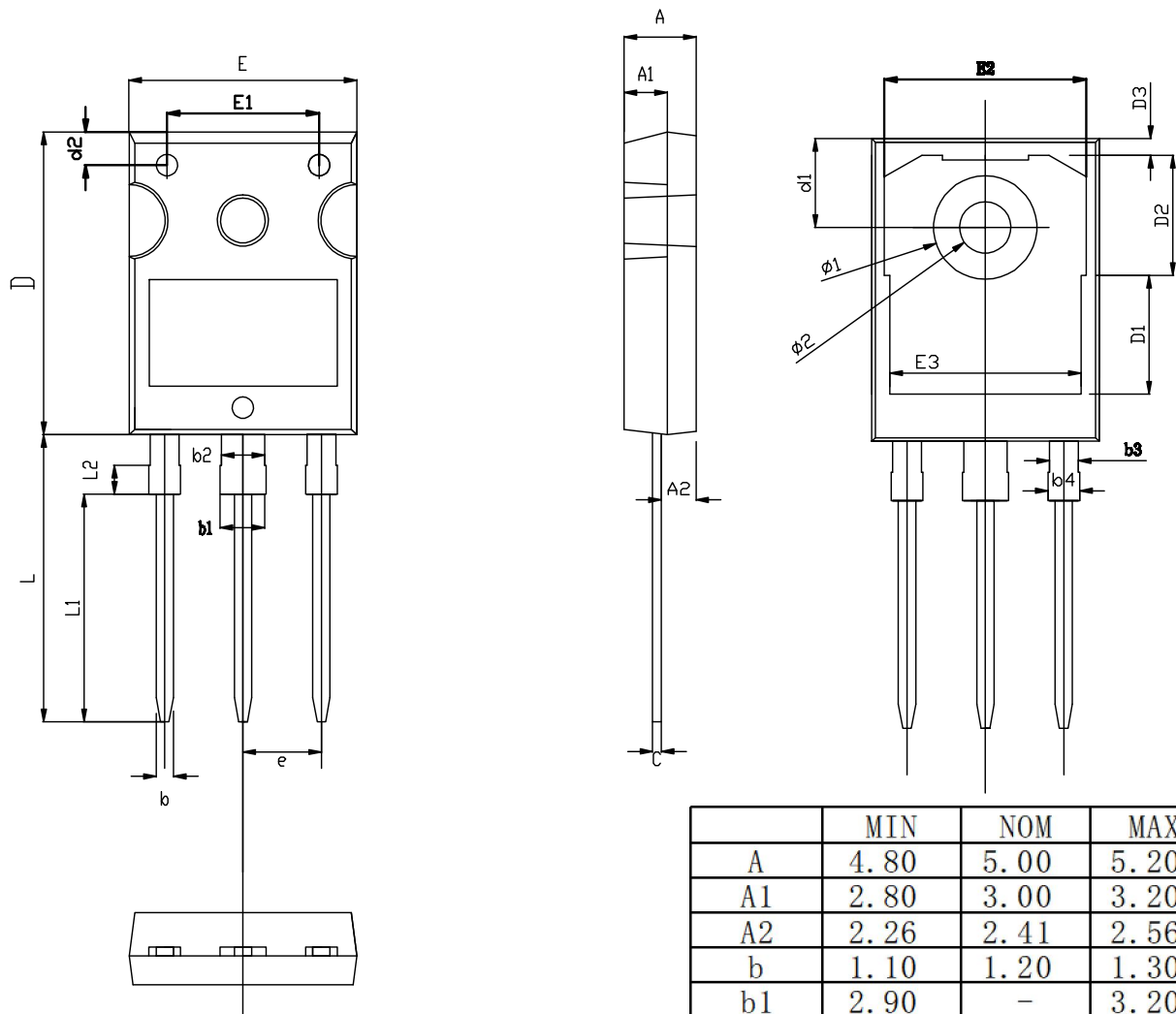

FIG.4-TYPICAL REVERSE CHARACTERISTICS



TO-247-3L PACKAGE OUTLINE



RECOMMENDED LAND PATTERN

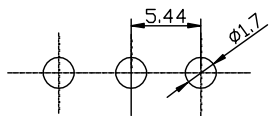

UNIT: mm

	MIN	NOM	MAX
A	4.80	5.00	5.20
A1	2.80	3.00	3.20
A2	2.26	2.41	2.56
b	1.10	1.20	1.30
b1	2.90	-	3.20
b2	2.90	3.00	3.10
b3	1.90	2.00	2.10
b4	2.00	-	2.20
c	0.50	0.60	0.70
D	20.80	21.00	21.20
D1		8.23	
D2		8.32	
D3		1.17	
d1	6.00	6.15	6.30
d2	2.20	2.30	2.40
E	15.60	15.80	16.00
E1		10.50	
E2		14.02	
E3		13.50	
e	5.34	5.44	5.54
L	19.72	19.92	20.12
L1		15.79	
L2		1.98	
$\phi 1$	7.10	7.19	7.30
$\phi 2$	3.50	3.60	3.70