

MUR5JGER

5.0AMPS .GLASS PASSIVATED ULTRA FAST RECTIFIERS

FEATURE

- . Low power loss, high efficiency
- . High surge capability
- . Super fast recovery time for high efficiency.
- . For surface mounted application.
- . Easy pick and place
- . High temperature soldering guaranteed:
260°C/10 seconds at terminals.

MECHANICAL DATA

- . Terminal: Solder plated
- . Case: Molded with UL-94 Class V-0 recognized
Flame Retardant Epoxy
- . Polarity: color band denotes cathode

SMC (DO-214AB)

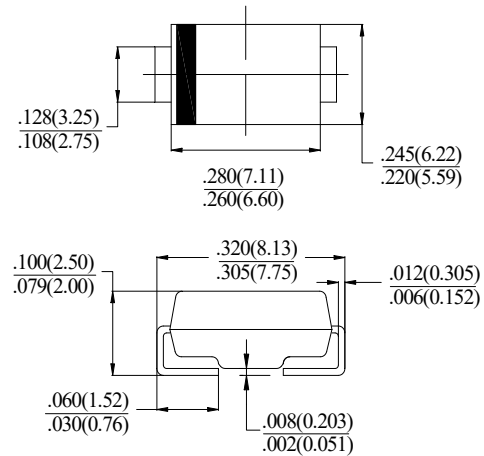

Dimensions in inches and (millimeters)

MAXIMUM RATINGS AND ELETRICAL CHARACTERISTICS

Ratings at 25°C ambient temperature unless otherwise specified.

Single phase, half wave, 60Hz, resistive or inductive load. For capacitive load, derate current by 20%

Type Number	SYM BOL	MUR5JGER	units
Maximum Recurrent Peak Reverse Voltage	V_{RRM}	600	V
Maximum RMS Voltage	V_{RMS}	420	V
Maximum DC blocking Voltage	V_{DC}	600	V
Maximum Average Forward Rectified Current	$I_{F(AV)}$	5.0	A
Peak Forward Surge Current 8.3ms single half sine- wave superimposed on rated load (JEDEC method)	I_{FSM}	120	A
Maximum Forward Voltage at 5.0A DC at 3.0A DC	V_F	Typ	Max
		1.2	1.50
		1.1	1.25
Maximum DC Reverse Current @ $T_J=25^\circ\text{C}$ at rated DC blocking voltage @ $T_J=125^\circ\text{C}$	I_R	5.0	μA
		200.0	
Maximum Reverse Recovery Time (Note 1)	t_{rr}	50	nS
Typical Junction Capacitance (Note 2)	C_J	50	pF
Typical Thermal Resistance (Note 3)	$R_{(JA)}$	50	$^\circ\text{C} / \text{W}$
	$R_{(JC)}$	15	
Storage Temperature	T_{STG}	-55 to +150	$^\circ\text{C}$
Operation Junction Temperature	T_J	-55 to +150	$^\circ\text{C}$

Note:

1. Test Conditions: $I_F=0.5\text{A}$, $I_R=1.0\text{A}$, $I_{RR}=0.25\text{A}$
2. Measured at 1.0 MHz and applied reverse voltage of 4.0Vdc
3. Measured on P.C.Board with 15.0×15.0*2.0mm Copper Pad Areas.

RATING AND CHARACTERISTIC CURVES

FIG.1-TYPICAL FORWARD CURRENT DERATING CURVE

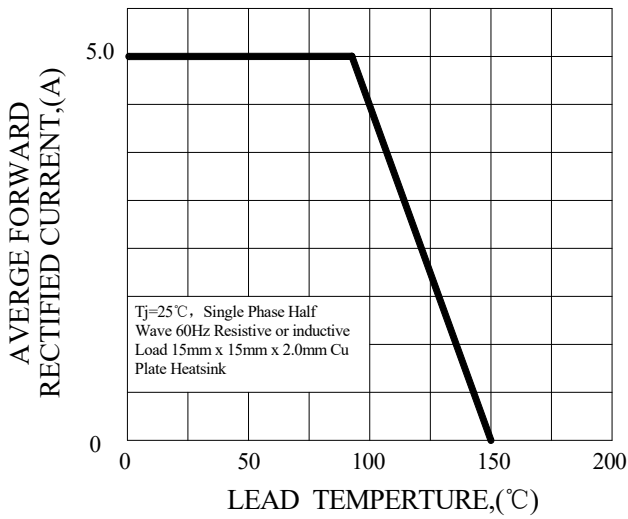

FIG.2-TYPICAL INSTANTANEOUS FORWARD CHARACTERISTICS

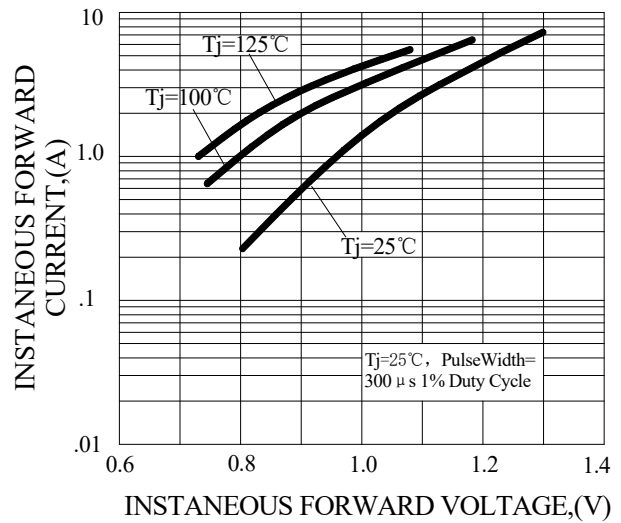

FIG.3-MAXIMUM NON-REPETITIVE FORWARD SURGE CURRENT

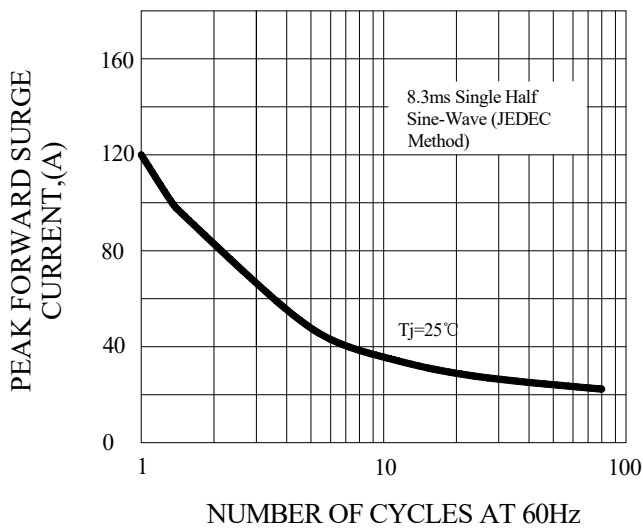

FIG.4-TYPICAL REVERSE CHARACTERISTICS

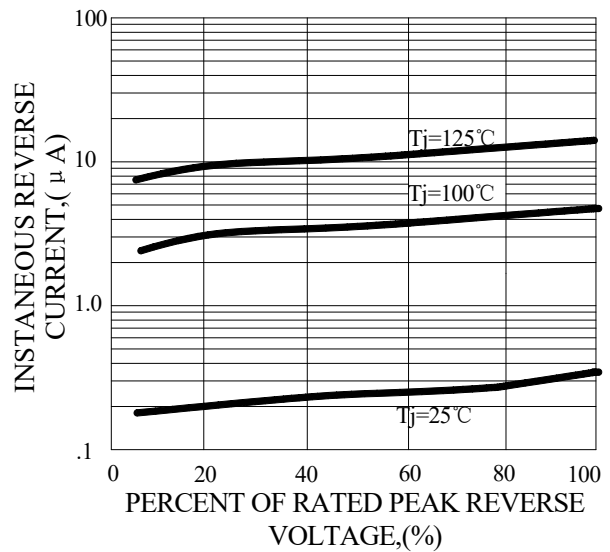
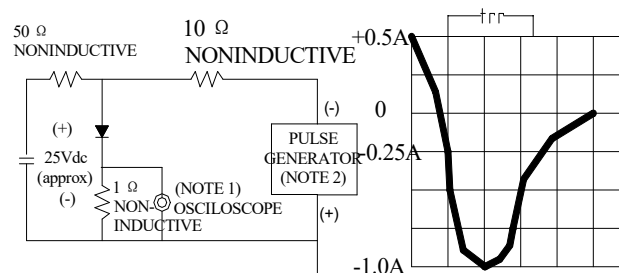

FIG.5-TEST CIRCUIT DIAGRAM AND REVERSE RECOVERY TIME CHARACTERISTIC



NOTES:1. Rise Time=7ns max, Input Impedance= 1 megohm.22pF.
2. Rise Time=10ns max, Source Impedance= 50 ohms.

Marking and packaging illustration

1、Marking

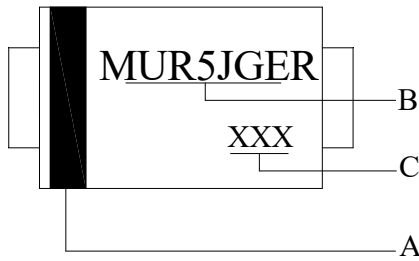

SYMBOL	Explanation
A	Color Band Denotes Cathode
B	Product name
C	Date Code

2、Packaging

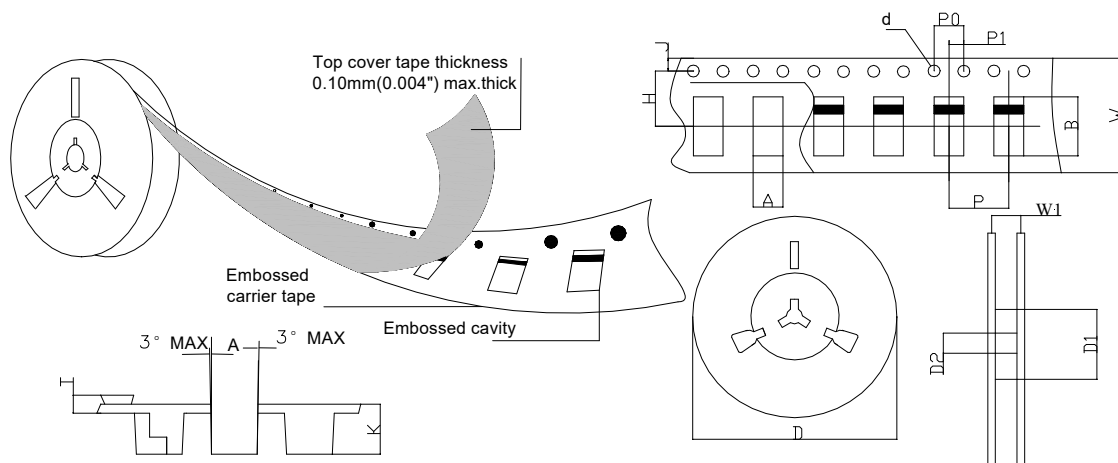

SPECIFICATIONS mm(inch)		PACKAGE	SPECIFICATIONS mm(inch)		PACKAGE
ITEM	SYM BOL	SMC (DO-214AB)	ITEM	SYM BOL	SMC (DO-214AB)
Carrier width	A	6.15(0.242)Max	Carrier depth	K	2.54(0.100)Typ
Carrier length	B	8.41(0.331)Max	Punch hole pitch	P	8.00(0.315)Typ
Sprocket hole	d	ø1.55(0.061)Typ	Sprocket hole pitch	P0	4.00(0.157)Typ
Reel outer diameter	D	330.0(13.0)Typ	Embossment center	P1	2.00(0.079)Typ
Reel inner diameter	D1	74.0(2.913)Min	Overall tape thickness	T	0.25(0.010)Typ
Feed hole diameter	D2	13.0(0.512)Typ	Tape width	W	16.0(0.430)Typ
Sprocket hole position	J	1.75(0.069)Typ	Reel width	W1	16.5(0.650)Min
Punch hole position	H	7.50(0.295)Typ			