

RS07D THRU RS07M

1.0 AMP. FAST RECOVERY RECTIFIERS

FEATURES

- Glass passivated device
- Ideal for surface mounted applications
- Low reverse leakage
- Metallurgically bonded construction
- High temperature soldering guaranteed:
250°C /10 seconds at terminals.

MECHANICAL DATA

- Case: JEDEC SOD-123FL, molded plastic over passivated chip, with UL-94 class V-0 recognized
- Terminals: Solder Plated, solderable per MIL-STD-750, Method 2026
- Polarity: Color band denotes cathode end
- Mounting position: Any

SOD-123FL

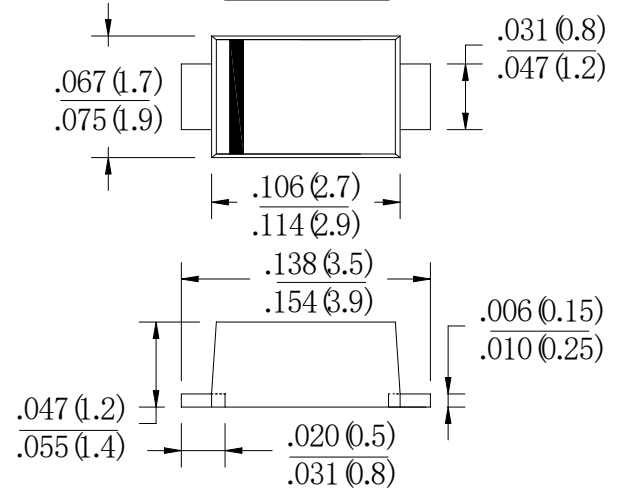

Dimensions in millimeters

MAXIMUM RATINGS AND ELECTRICAL CHARACTERISTICS

Ratings at 25°C ambient temperature unless otherwise specified.

Single phase, half wave, 60Hz, resistive or inductive load. For capacitive load, derate current by 20%.

Type Number	SYMBOL	RS07D	RS07G	RS07J	RS07M	units
	marking	RD	RG	RJ	RM	
Maximum Recurrent Peak Reverse Voltage	V_{RRM}	200	400	600	1000	V
Maximum RMS Voltage	V_{RMS}	140	280	420	700	V
Maximum DC Blocking Voltage	V_{DC}	200	400	600	1000	V
Maximum Average Forward rectified	$I_{F(AV)}$	1.0				A
Peak Forward Surge Current 8.3ms single Half sine-wave superimposed on rate load (JEDEC method)	I_{FSM}	30				A
Maximum forward Voltage at 1.0 A DC	V_F	1.3				V
Maximum DC Reverse Current @ $T_J=25^\circ\text{C}$ at rated DC blocking voltage @ $T_J=125^\circ\text{C}$	I_R	5.0 200.0				μA
Maximum Reverse Recovery Time (Note 1)	t_{rr}	150	250	500		nS
Typical Junction Capacitance (Note 2)	C_J	7				pF
Typical thermal resistance (Note 3)	$R_{(JA)}$	180				$^\circ\text{C}/\text{W}$
	$R_{(JC)}$	35				
Storage Temperature Range	T_{STG}	-55 to +150				$^\circ\text{C}$
Operation Temperature Range	T_J	-55 to +150				$^\circ\text{C}$

Note:

1. Test Conditions: $I_F=0.5\text{A}$, $I_R=1.0\text{A}$, $I_{RR}=0.25\text{A}$
2. Measured at 1MHz and applied reverse voltage of 4.0 volts d.c.
3. Measured on P.C.Board with 0.2×0.2”(5.0×5.0mm) Copper Pad Areas

RATING AND CHARACTERISTIC CURVES

FIG.1-TYPICAL FORWARD CURRENT DERATING CURVE

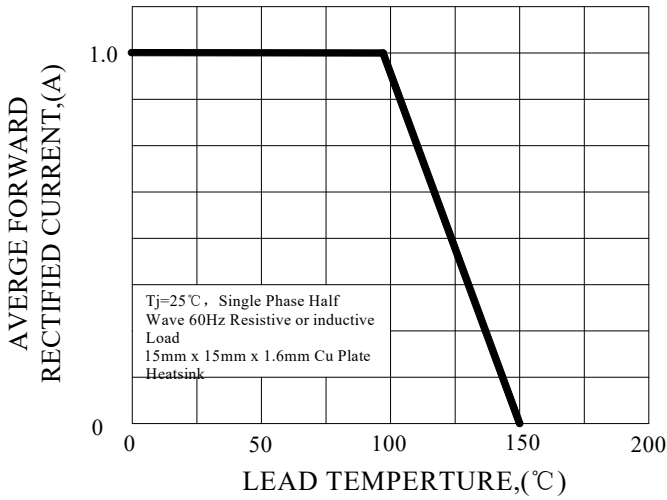

FIG.2-TYPICAL INSTANTANEOUS FORWARD CHARACTERISTICS

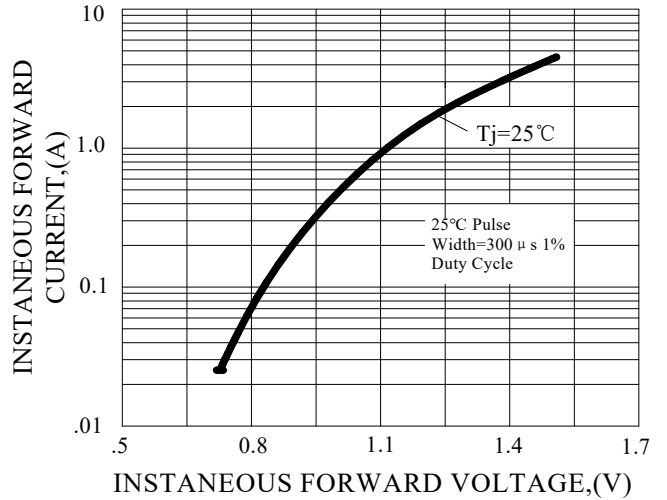

FIG.3-MAXIMUM NON-REPETITIVE FORWARD SURGE CURRENT

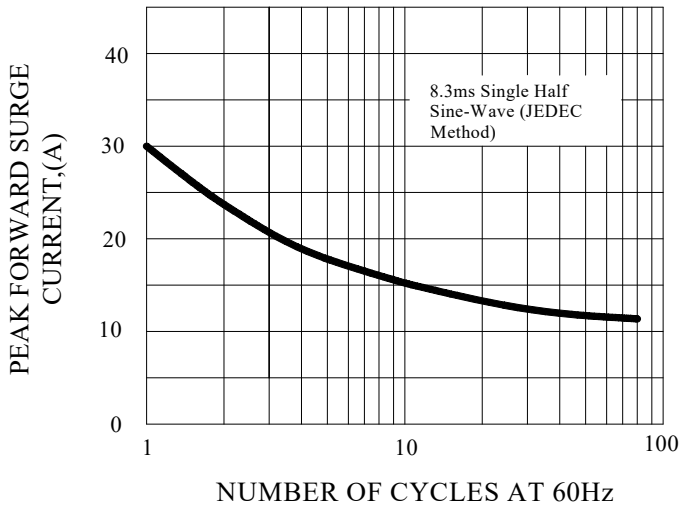

FIG.4-TYPICAL REVERSE CHARACTERISTICS

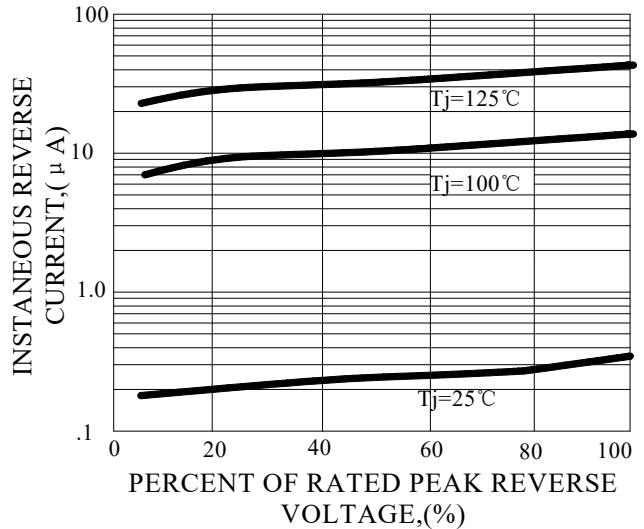
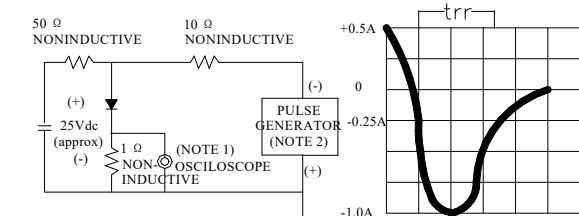
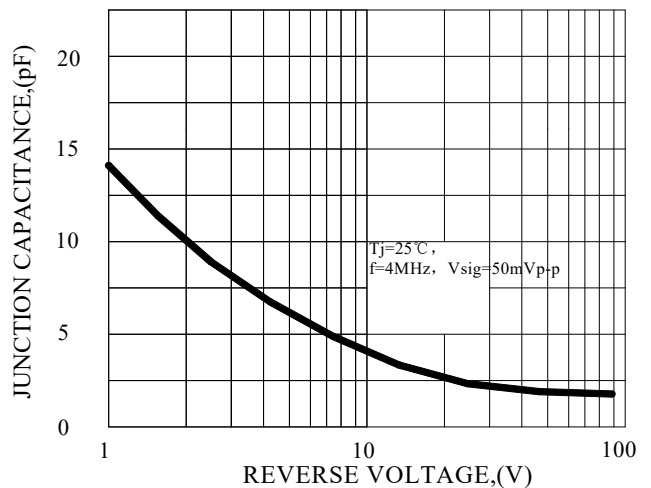

FIG.5-TEST CIRCUIT DIAGRAM AND REVERSE RECOVERY TIME CHARACTERISTIC



NOTES:1. Rise Time=7ns max, Input Impedance= 1 megohm, 22pF.
2. Rise Time=10ns max, Source Impedance= 50 ohms.

FIG.6-TYPICAL JUNCTION CAPACITANCE



Marking and packaging illustration

1、Marking

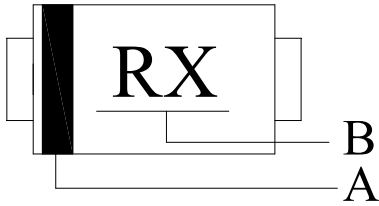

SYMBOL	Explanation
A	Color Band Denotes Cathode
B	Product Name

2、Packaging

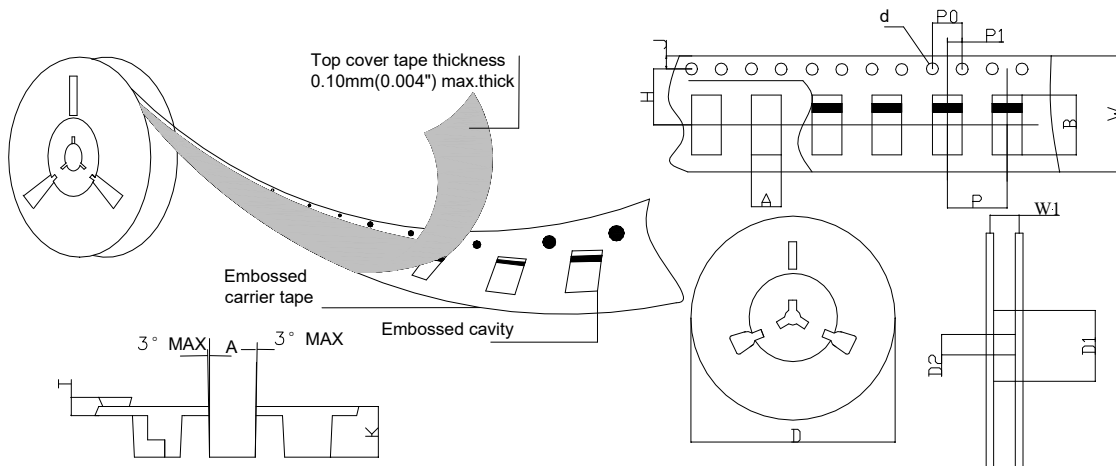

SPECIFICATIONS mm(inch)		PACKAGE	SPECIFICATIONS mm(inch)		PACKAGE
ITEM	SYM BOL	SOD-123FL	ITEM	SYM BOL	SOD-123FL
Carrier width	A	2.1(0.083)Max	Carrier depth	K	1.60(0.063)Typ
Carrier length	B	4.0(0.157)Max	Punch hole pitch	P	4.00(0.157)Typ
Sprocket hole	d	ø1.55(0.061)Typ	Sprocket hole pitch	P0	4.00(0.157)Typ
Reel outer diameter	D	177.8(7)Typ	Embossment center	P1	2.00(0.079)Typ
Reel inner diameter	D1	50.0(1.969)Min	Overall tape thickness	T	0.25(0.098)Typ
Feed hole diameter	D2	13.0(0.512)Typ	Tape width	W	8.15(0.321)Typ
Sprocket hole position	J	1.75(0.069)Typ	Reel width	W1	10.5(0.413)Min
Punch hole position	H	3.50(0.138)Typ			