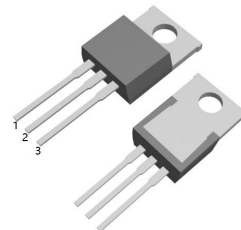
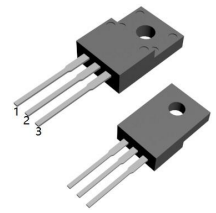

PSM40U100CT&PSM40U100FCT

40.0AMPS. SCHOTTKY BARRIER RECTIFIERS

FEATURE

- . High current capability
- . Ultra low forward voltage drop
- . Low power loss, high efficiency
- . High surge capability
- . High temperature soldering guaranteed
260°C /10seconds, 0.25"(6.35mm)from case.

 TO-220AB-3L
 PSM40U100CT

 TO-220F-3L
 PSM40U100FCT

MECHANICAL DATA

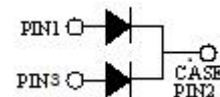
- . Case: Molded with UL-94 Class V-0 recognized
Flame Retardant Epoxy
- . Mounting position: any



Single phase, half wave, 60Hz, resistive or inductive load.

For capacitive load, derate current by 20%

MAXIMUM RATINGS (T_C=25°C unless otherwise noted)

Parameter	Symbol	PSM40U100CT&PSM40U100FCT	Units
Maximum Recurrent Peak Reverse Voltage	V_{RRM}	100	V
Maximum RMS Voltage	V_{RMS}	70	V
Maximum DC blocking Voltage	V_{DC}	100	V
Maximum Average Forward Rectified Current <i>Per Leg</i> at T _C =100°C <i>Total device</i>	$I_{F(AV)}$	20.0 40.0	A
Peak Forward Surge Current 8.3ms single half sine-wave superimposed on rated load (JEDEC method) <i>Per Leg</i>	I_{FSM}	250.0	A
Typical Junction Capacitance (Note 1)	C_J	1450	pF
Operation Junction Temperature and Storage Temperature	T_J, T_{STG}	-55 to +150	°C

ELECTRICAL CHARACTERISTICS -(per leg) (T_C=25°C unless otherwise noted)

Parameter	Symbol	Test conditions	Typ	Max	Units	
Forward voltage drop	V_F	T _J =25°C	I _F =3A	0.44	---	V
			I _F =5A	0.48	---	
			I _F =20A	0.72	0.80	
		T _J =125°C	I _F =3A	0.34	---	
			I _F =5A	0.40	---	
			I _F =20A	0.65	0.70	
Reverse leakage current	I_R	T _J =25°C	V _R =100V	---	100	μA
		T _J =125°C	V _R =100V	---	40	mA

THERMAL CHARACTERISTICS(T_C=25°C unless otherwise noted)

Parameter	Symbol	PSM40U100CT	PSM40U100FCT	Units
Typical Thermal Resistance (Note 2)	$R_{(JC)}$	2.5	3.5	°C/W

Notes:1. Measured at 1.0 MHz and applied reverse voltage of 4.0Vdc

2. Thermal Resistance from Junction to Case

RATING AND CHARACTERISTIC CURVES

FIG.1-TYPICAL FORWARD CURRENT DERATING CURVE

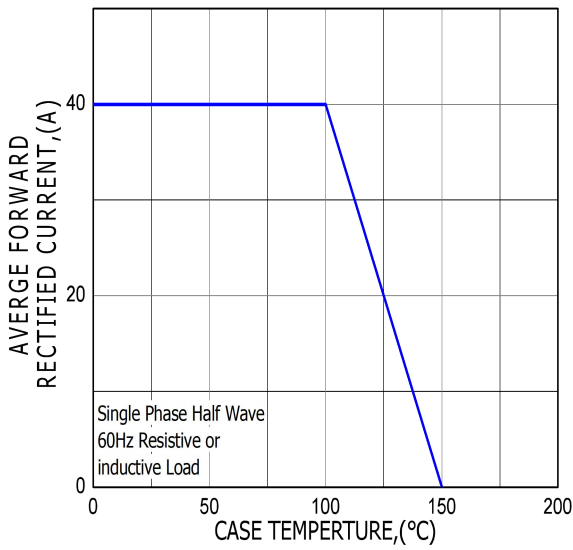

FIG.2-TYPICAL INSTANTANEOUS FORWARD CHARACTERISTICS

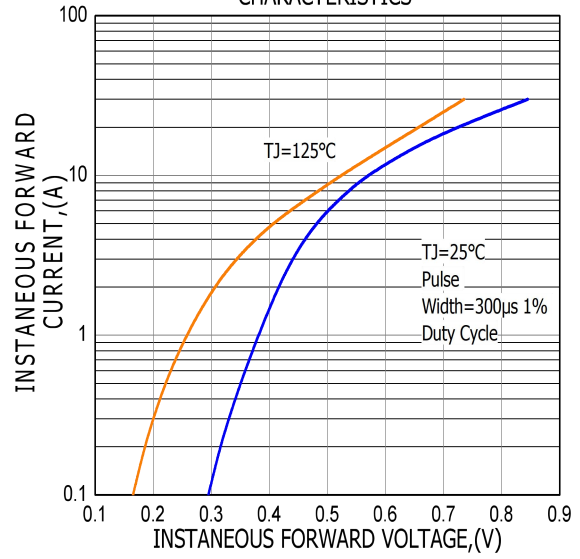

FIG.3-MAXIMUM NON-REPETITIVE FORWARD SURGE CURRENT

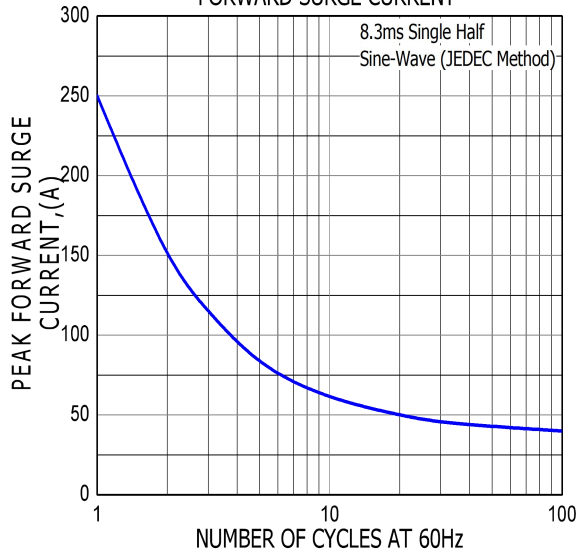
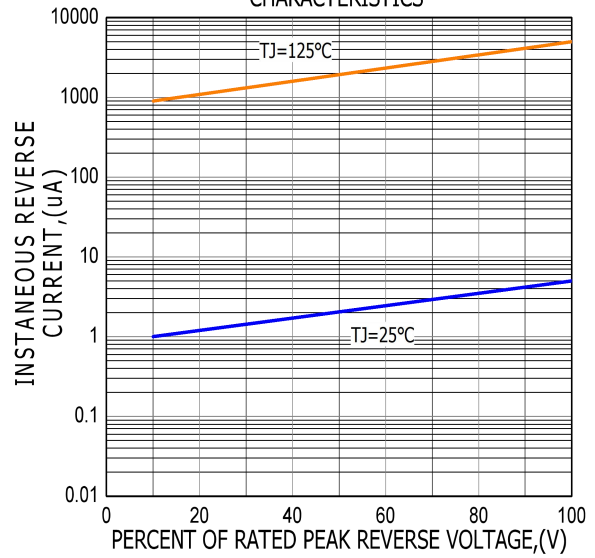
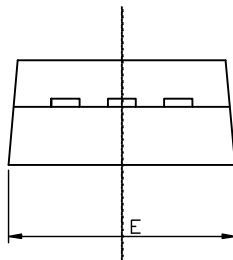
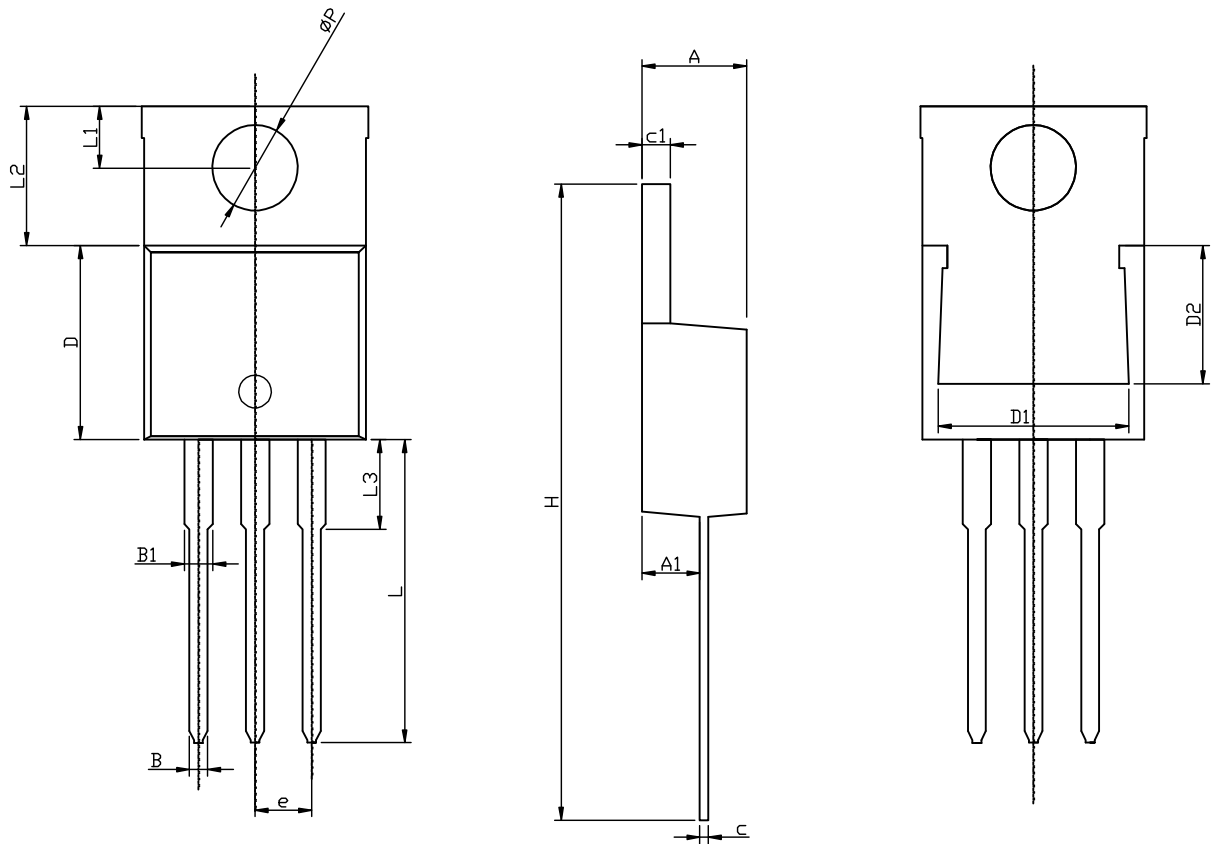

FIG.4-TYPICAL REVERSE CHARACTERISTICS



TO-220AB-3L PACKAGE OUTLINE



RECOMMENDED LAND PATTERN

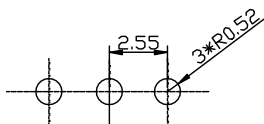

UNIT: mm

	MIN	NOM	MAX
A	4.50	4.70	4.90
A1	2.45	2.60	2.70
B	0.72	0.82	0.92
B1	1.12	1.27	1.42
c	0.28	0.38	0.48
c1	1.17	1.27	1.37
D	8.46	8.66	8.86
D1	7.90	8.10	8.40
D2	5.50	5.70	5.90
e	2.45	2.55	2.65
E	9.85	10.15	10.45
H	28.00	28.50	29.00
ϕP		3.84	
L	13.1	13.6	14.1
L1	2.54	2.74	2.94
L2	6.04	6.24	6.44
L3	3.85	4.05	4.35

TO-220F-3L PACKAGE OUTLINE

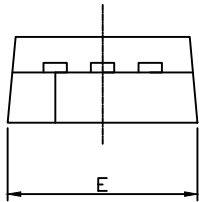
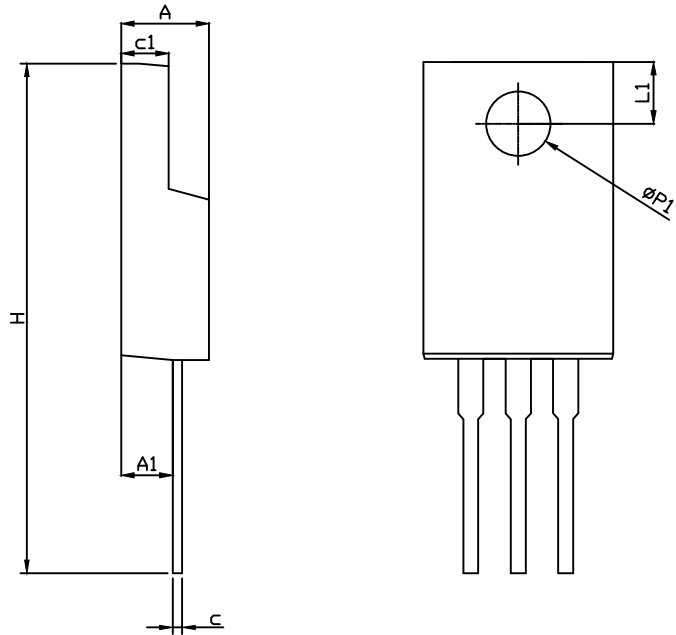
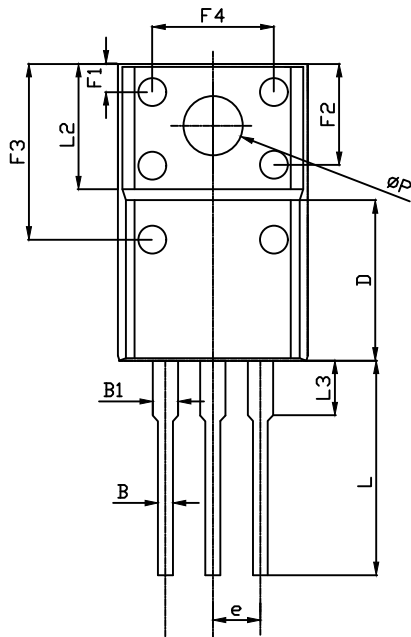

RECOMMENDED LAND PATTERN

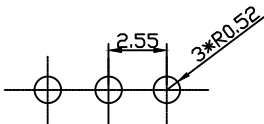

UNIT: mm

	MIN	NOM	MAX
A	4.40	4.60	4.80
A1	2.63	2.76	2.89
B	0.75	0.80	0.90
B1	1.12	1.27	1.42
c	0.40	0.50	0.60
c1	2.60	2.70	2.80
D	7.50	7.80	8.10
e	-	2.55REF	-
E	9.86	10.00	10.10
F1	1.90	2.12	2.40
F2	5.00	5.30	5.65
F3	8.70	9.00	9.30
F4	6.20	6.50	6.80
H	27.80	28.30	28.80
L	13.10	13.30	13.50
L1	2.85	3.00	3.15
L2	-	6.70REF	-
L3	3.10	3.60	4.10
ΦP	3.00	3.30	3.60
ΦP1	2.80	3.10	3.40