

DSS115

1.0 AMP. SURFACE MOUNT GENERAL PURPOSE SCHOTTKY BARRIER RECTIFIERS

FEATURES

- For surface mounted application
- High current capability
- Low forward voltage drop
- Low power loss, high efficiency
- High surge current capability
- High temperature soldering guaranteed:
250°C/10 seconds at terminals.

MECHANICAL DATA

- Case: JEDEC SOD-123FL,molded plastic over passivated chip
- Terminals:Solder Plated, solderable per MIL-STD-750, Method 2026
- Polarity: Color band denotes cathode end
- Weight: 0.006 ounces, 0.02 gram
- Mounting position: Any

SOD-123FL

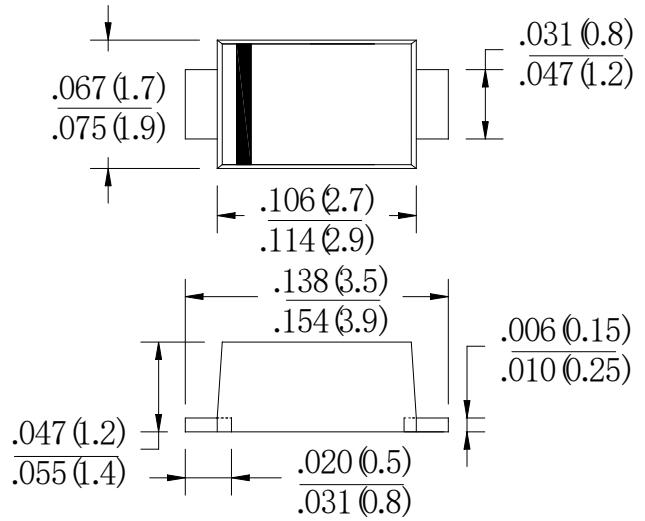

MAXIMUM RATINGS AND ELECTRICAL CHARACTERISTICS

Ratings at 25°C ambient temperature unless otherwise specified.

Single phase, half wave, 60Hz,resistive or inductive load. For capacitive load, derate current by 20%.

Type Number	SYM BOL	DSS115	units
	marking	D115	
Maximum Recurrent Peak Reverse Voltage	V_{RRM}	150	V
Maximum RMS Voltage	V_{RMS}	105	V
Maximum DC Blocking Voltage	V_{DC}	150	V
Maximum Average Forward rectified Current	$I_{F(AV)}$	1.0	A
Peak Forward Surge Current 8.3ms single half sine-wave superimposed on rate load (JEDEC method)	I_{FSM}	30.0	A
Maximum forward Voltage at 1.0 A DC	V_F	0.95	V
Maximum DC Reverse Current @ $T_J=25^{\circ}C$ at rated DC blocking voltage @ $T_J=100^{\circ}C$	I_R	0.1	mA
		10.0	
Typical Junction Capacitance (Note 1)	C_J	23	pF
Typical thermal resistance (Note 2)	$R_{(JA)}$	180	°C /W
Storage Temperature Range	T_{STG}	-55 to +150	°C
Operation Temperature Range	T_J	-55 to +150	°C

Note:

1. Measured at 1MHz and applied reverse voltage of 4.0 volts d.c.
2. Measured on P.C.Board with 0.2×0.2”(5.0×5.0mm)Copper Pad Areas

RATING AND CHARACTERISTIC CURVES

FIG.1-TYPICAL FORWARD CURRENT DERATING CURVE

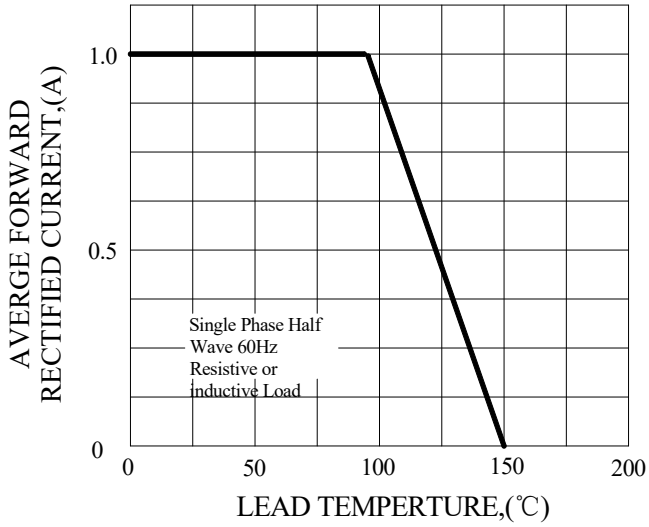

FIG.2-TYPICAL INSTANTANEOUS FORWARD CHARACTERISTICS

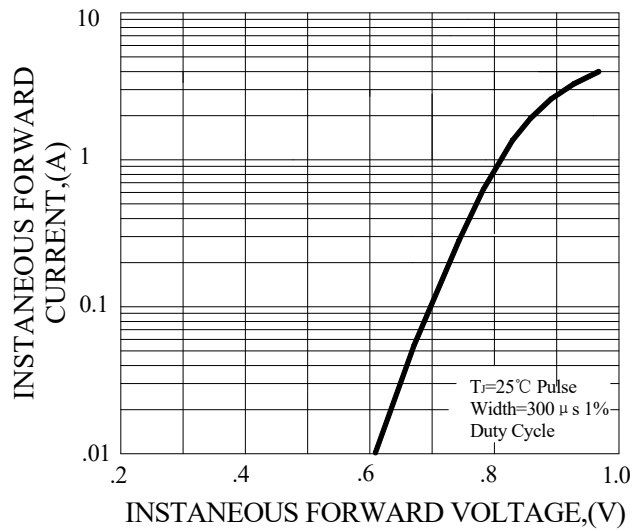

FIG.3-MAXIMUM NON-REPETITIVE FORWARD SURGE CURRENT

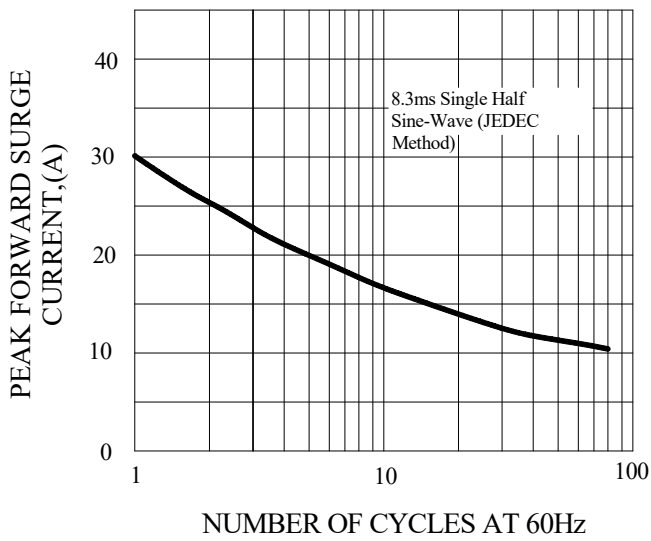
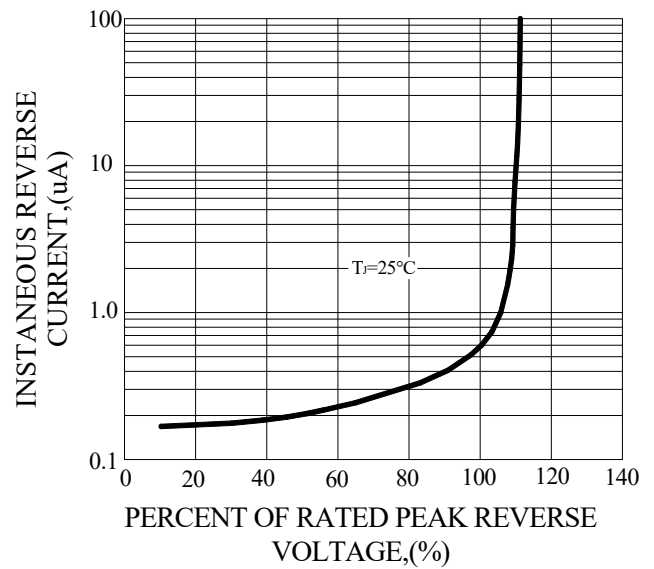
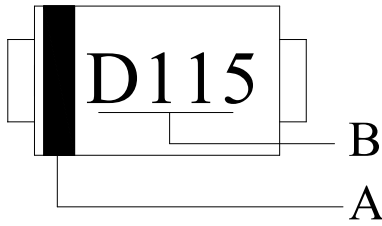

FIG.4-TYPICAL REVERSE CHARACTERISTICS



Marking and packaging illustration

1、Marking



SYMBOL	Explanation
A	Color Band Denotes Cathode
B	Product Name

2、Packaging

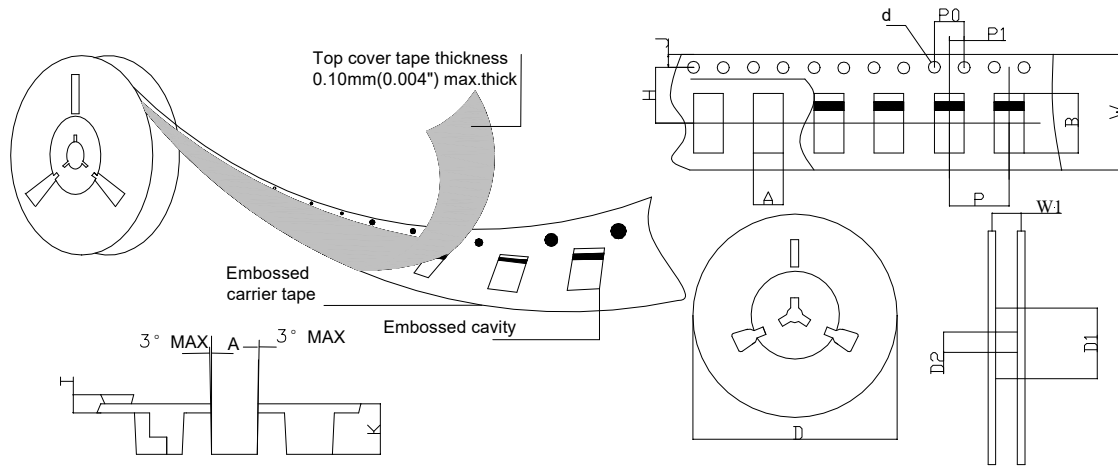

SPECIFICATIONS mm(inch)		PACKAGE	SPECIFICATIONS mm(inch)		PACKAGE
ITEM	SYM BOL	SOD-123FL	ITEM	SYM BOL	SOD-123FL
Carrier width	A	2.1(0.083)Max	Carrier depth	K	1.60(0.063)Typ
Carrier length	B	4.0(0.157)Max	Punch hole pitch	P	4.00(0.157)Typ
Sprocket hole	d	ø1.55(0.061)Typ	Sprocket hole pitch	P0	4.00(0.157)Typ
Reel outer diameter	D	177.8(7)Typ	Embossment center	P1	2.00(0.079)Typ
Reel inner diameter	D1	50.0(1.969)Min	Overall tape thickness	T	0.25(0.098)Typ
Feed hole diameter	D2	13.0(0.512)Typ	Tape width	W	8.15(0.321)Typ
Sprocket hole position	J	1.75(0.069)Typ	Reel width	W1	10.5(0.413)Min
Punch hole position	H	3.50(0.138)Typ			