

## RS2GG THRU RS2MG

### 2.0AMPS. FAST RECOVERY SURFACE MOUNT RECTIFIERS

#### FEATURE

- . Fast switching
- . High current capability
- . Low forward voltage drop
- . Low power loss, high efficiency
- . High surge capability
- . High temperature soldering guaranteed:  
260°C/10 seconds at terminals.
- . For surface mounted application.
- . Easy pick and place.

#### MECHANICAL DATA

- . Case: Molded plastic
- . Epoxy: UL94V-0 rate flame retardant
- . Lead: MIL-STD- 202E, Method 208 guaranteed
- . Polarity:Color band denotes cathode end
- . Packaging:12mm tape per EIA STD RS-481
- . Mounting position: Any

#### SMB (DO-214AA)

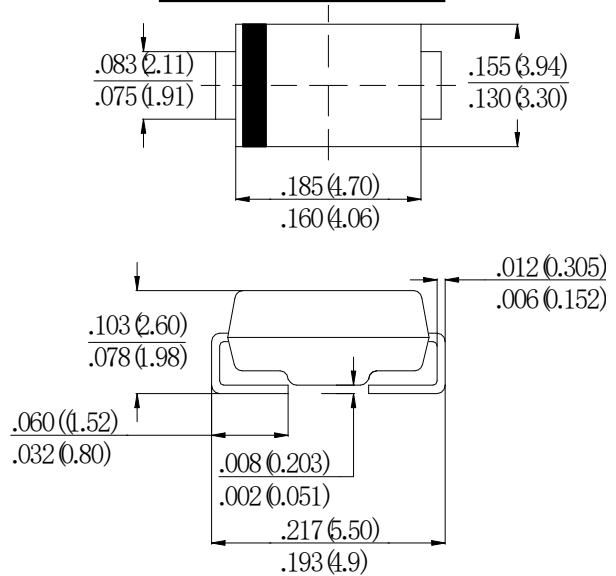

#### MAXIMUM RATINGS AND ELECTRICAL CHARACTERISTICS

Ratings at 25°C ambient temperature unless otherwise specified.

Single phase, half wave, 60Hz, resistive or inductive load. For capacitive load, derate current by 20%

Type Number	SYM BOL	RS2GG	RS2JG	RS2MG	units
Maximum Recurrent Peak Reverse Voltage	$V_{RRM}$	400	600	1000	V
Maximum RMS Voltage	$V_{RMS}$	280	420	700	V
Maximum DC blocking Voltage	$V_{DC}$	400	600	1000	V
Maximum Average Forward Rectified Current	$I_{F(AV)}$	2.0			A
Peak Forward Surge Current 8.3ms single half sine- wave superimposed on rated load (JEDEC method)	$I_{FSM}$	60.0			A
Maximum Forward Voltage at 2.0A DC	$V_F$	1.3			V
Maximum DC Reverse Current @ $T_J=25^\circ\text{C}$ at rated DC blocking voltage @ $T_J=125^\circ\text{C}$	$I_R$	5.0 100.0			$\mu\text{A}$
Maximum Reverse Recovery Time (Note 1)	$t_{rr}$	150	250	500	nS
Typical Junction Capacitance (Note 2)	$C_J$	15	13		pF
Typical Thermal Resistance (Note 3)	$R_{(JA)}$	50			$^\circ\text{C}/\text{W}$
	$R_{(JC)}$	20			
Storage Temperature	$T_{STG}$	-55 to +150			$^\circ\text{C}$
Operation Junction Temperature	$T_J$	-55 to +150			$^\circ\text{C}$

#### Note:

1. Test Conditions:  $I_F=0.5\text{A}$ ,  $I_R=1.0\text{A}$ ,  $I_{RR}=0.25\text{A}$
2. Measured at 1.0 MHz and applied reverse voltage of 4.0Vdc
3. Measured on P.C.Board with  $0.2 \times 0.2''$  ( $5.0 \times 5.0\text{mm}$ ) Copper Pad Areas.

**RATING AND CHARACTERISTIC CURVES**

FIG.1-TYPICAL FORWARD CURRENT DERATING CURVE

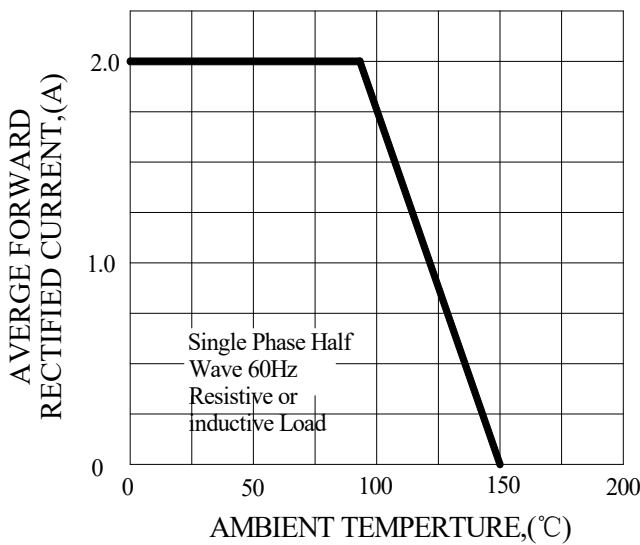

FIG.2-TYPICAL INSTANTANEOUS FORWARD CHARACTERISTICS

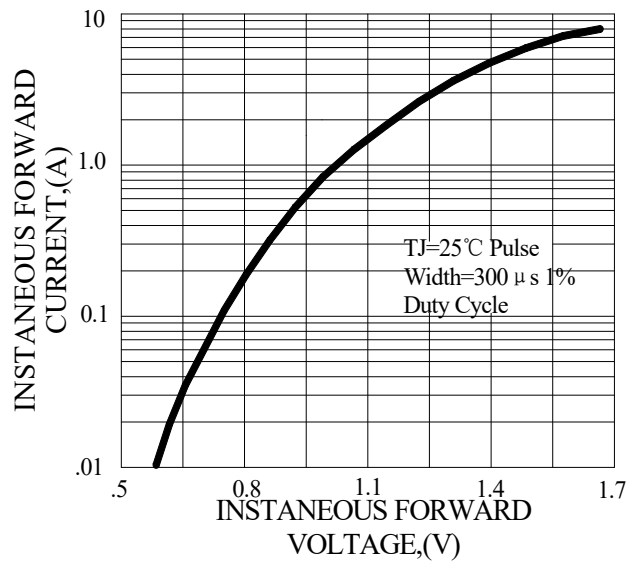

FIG.3-MAXIMUN NON-REPETITIVE FORWARD SURGE CURRENT

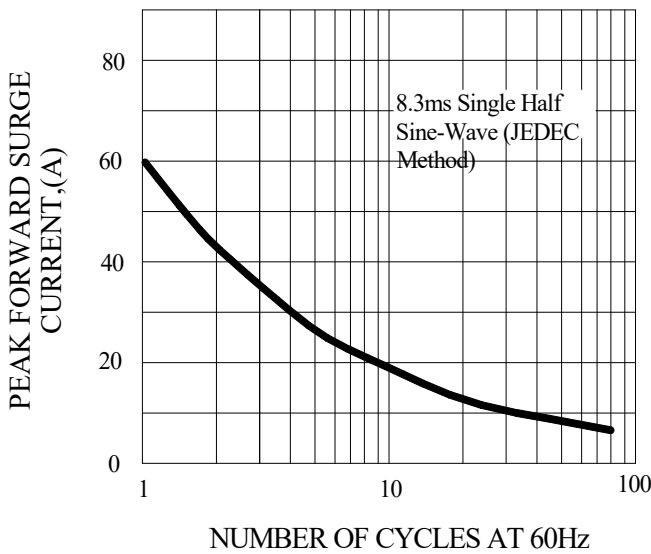

FIG.4-TYPICAL REVERSE CHARACTERISTICS

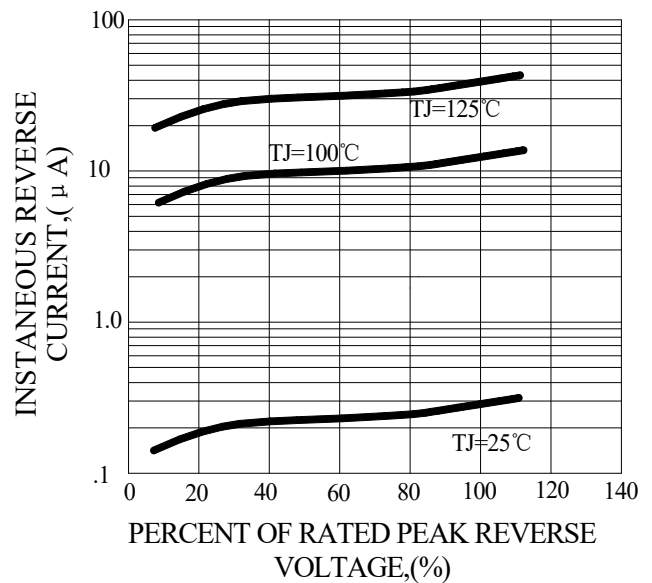
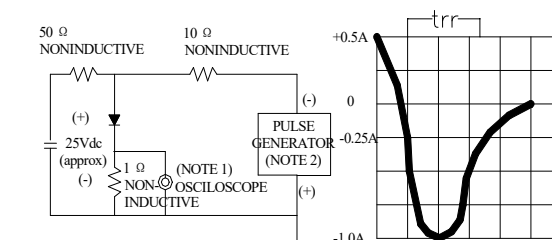

FIG.5-TEST CIRCUIT DIAGRAM AND REVERSE RECOVERY TIME CHARACTERISTIC



NOTES: 1. Rise Time=7ns max, Input Impedance= 1 megohm.22pF.  
2. Rise Time=10ns max, Source Impedance= 50 ohms.

## Marking and packaging illustration

### 1、Marking

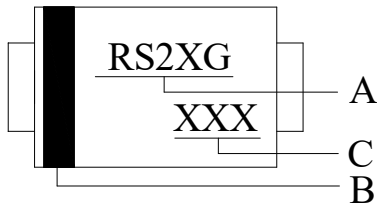

SYMBOL	Explanation
<b>A</b>	<b>Product Name</b>
<b>B</b>	<b>Color Band Denotes Cathode</b>
<b>C</b>	<b>Date Code</b>

### 2、Packaging

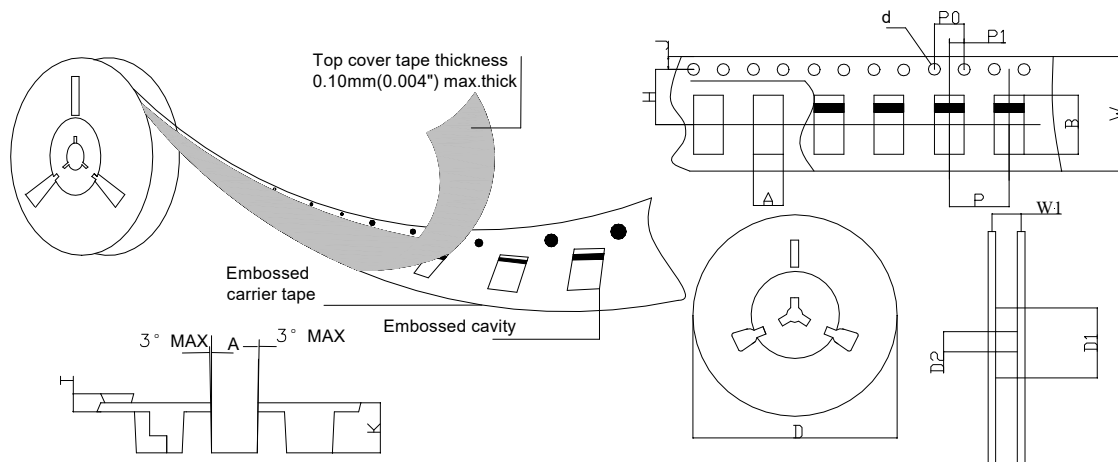

SPECIFICATIONS mm(inch)		PACKAGE	SPECIFICATIONS mm(inch)		PACKAGE
ITEM	SYM BOL	SMB (DO-214AA)	ITEM	SYM BOL	SMB (DO-214AA)
Carrier width	A	3.81(0.150)Max	Carrier depth	K	2.45(0.965)Typ
Carrier length	B	5.41(0.213)Max	Punch hole pitch	P	8.00(0.315)Typ
Sprocket hole	d	ø1.55(0.061)Typ	Sprocket hole pitch	P0	4.00(0.157)Typ
Reel outer diameter	D	330.0(13.0)Typ	Embossment center	P1	2.00(0.079)Typ
Reel inner diameter	D1	50.0(1.969)Min	Overall tape thickness	T	0.30(0.012)Typ
Feed hole diameter	D2	13.0(0.512)Typ	Tape width	W	12.0(0.472)Typ
Sprocket hole position	J	1.75(0.069)Typ	Reel width	W1	12.4(0.488)Min
Punch hole position	H	5.55(0.219)Typ			