

PW30D5W
30V N-Channel MOSFET

0.6A 30V; $R_{DS(ON)typ}=320m\Omega@4.5V$, $R_{DS(ON)typ}=410m\Omega@2.5V$,

FEATURE

- Surface Mount Package
- N-Channel Switch with Low $R_{DS(on)}$
- Operated at Low Logic Level Gate Drive

Application

- Load/Power Switching
- Interfacing Switching
- Battery Management for Ultra Small Portable Electronics
- Logic Level Shift

MARKING:

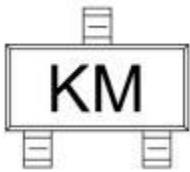

SOT-323

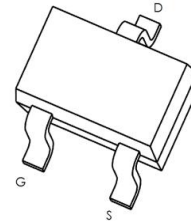

Schematic diagram

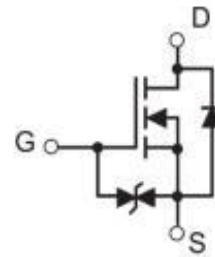

ABSOLUTE MAXIMUM RATINGS ($T_a=25^{\circ}C$ unless otherwise noted)

Parameter	Symbol	Value	Unit
Drain-Source Voltage	V_{DS}	30	V
Gate-Source Voltage	V_{GS}	± 12	V
Continuous Drain Current	I_D	0.6	A
Pulsed Drain Current ⁽¹⁾	I_{DM}	1.8	A
Power Dissipation ⁽²⁾	P_D	200	mW
Thermal Resistance from Junction to Ambient ⁽¹⁾	$R_{\theta JA}$	625	$^{\circ}C/W$
Junction Temperature	T_J	150	$^{\circ}C$
Storage Temperature	T_{STG}	-55~ +150	$^{\circ}C$

MOSFET ELECTRICAL CHARACTERISTICS(T_a=25°C unless otherwise noted)

Parameter	Symbol	Test Condition	Min	Type	Max	Unit
STATIC CHARACTERISTICS						
Drain-source breakdown voltage	V _{(BR)DSS}	V _{GS} = 0V, I _D = 250μA	30			V
Zero gate voltage drain current	I _{DSS}	V _{DS} = 30V, V _{GS} = 0V			1	μA
Gate-body leakage current	I _{GSS}	V _{GS} = ±10V, V _{DS} = 0V			±3	μA
Gate threshold voltage ⁽³⁾	V _{GS(th)}	V _{DS} = V _{GS} , I _D = 250μA	0.5	1.0	1.5	V
Drain-source on-resistance ⁽³⁾	R _{DS(on)}	V _{GS} = 4.5V, I _D = 0.6A		320	420	mΩ
		V _{GS} = 2.5V, I _D = 0.3A		410	540	
Forward tranconductance	g _{FS}	V _{DS} = 5V, I _D = 0.5A	0.1			S
DYNAMIC CHARACTERISTICS⁽⁴⁾						
Input Capacitance	C _{iss}	V _{DS} = 10V, V _{GS} = 0V, f = 1MHz		44		pF
Output Capacitance	C _{oss}			15		
Reverse Transfer Capacitance	C _{rss}			8		
Total gate charge	Q _g	V _{DS} = 15V, V _{GS} = 4.5V, I _D = 0.8A		1.2		nC
Gate-source charge	Q _{gs}			0.28		
Gate-drain charge	Q _{gd}			0.3		
SWITCHING CHARACTERISTICS						
Turn-on delay time	t _{d(on)}	V _{DS} = 15V, I _D = 0.7A, V _{GS} = 4.5V, R _G = 51Ω		5.0		ns
Turn-on rise time	t _r			8.2		
Turn-off delay time	t _{d(off)}			23		
Turn-off fall time	t _f			41		
SOURCE-DRAIN DIODE CHARACTERISTICS						
Diode Forward voltage ⁽³⁾	V _{DS}	I _S = 0.6A, V _{GS} = 0V		0.87	1.2	V

Notes:

1. Repetitive Rating: Pulse width limited by maximum junction temperature.
2. This test is performed with no heat sink at T_a = 25°C .
3. Pulse Test : Pulse Width ≤ 300μs, Duty Cycle ≤ 0.5%.
4. These parameters have no way to verify.

Typical Electrical and Thermal Characteristics

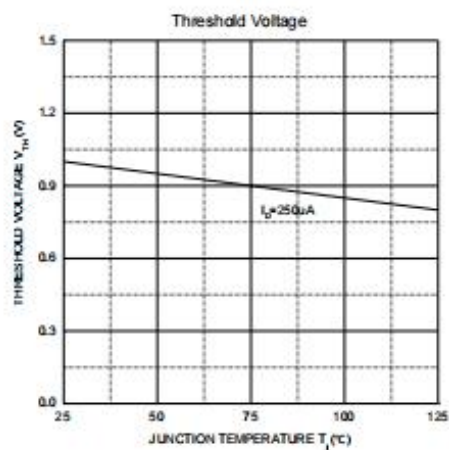
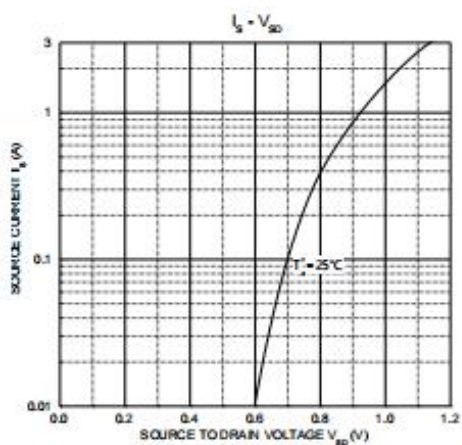
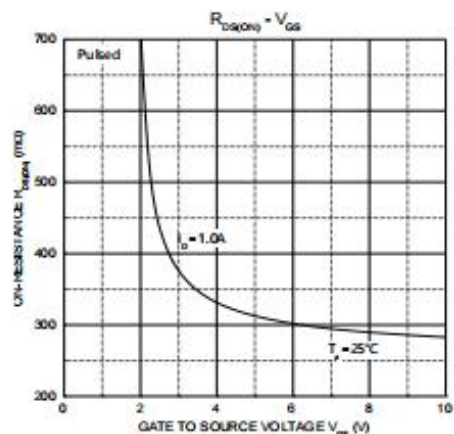
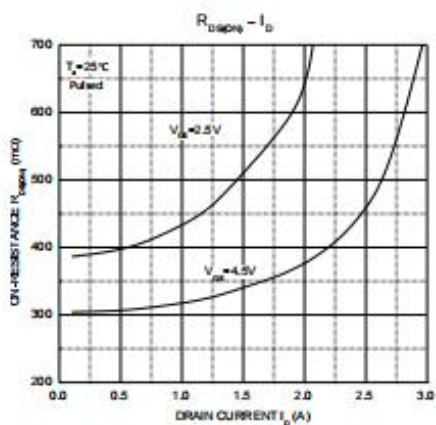
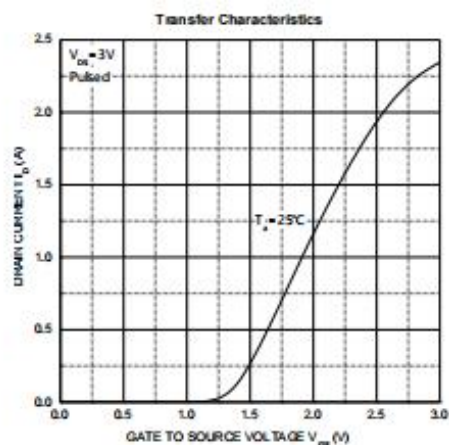
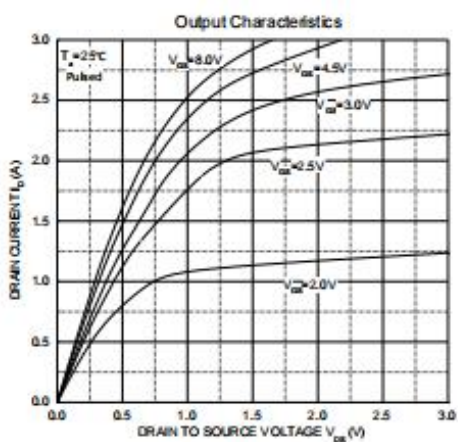

SOT-323 Package Information

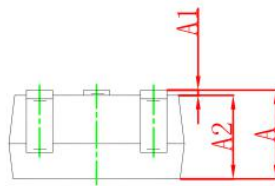
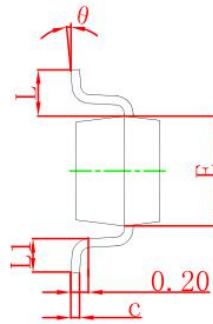
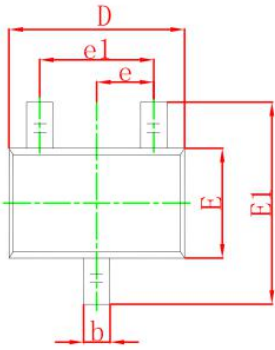

Symbol	Dimensions In Millimeters		Dimensions In Inches	
	Min	Max	Min	Max
A	0.900	1.100	0.035	0.043
A1	0.000	0.100	0.000	0.004
A2	0.900	1.000	0.035	0.039
b	0.200	0.400	0.008	0.016
c	0.080	0.150	0.003	0.006
D	2.000	2.200	0.079	0.087
E	1.150	1.350	0.045	0.053
E1	2.150	2.450	0.085	0.096
e	0.650 TYP		0.026 TYP	
e1	1.200	1.400	0.047	0.055
L	0.525 REF		0.021 REF	
L1	0.260	0.460	0.010	0.018
θ	0°	8°	0°	8°

SOT-323 Tape and Reel

SOT-323 Embossed Carrier Tape

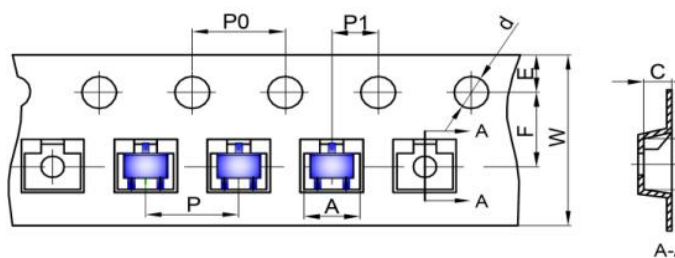

Dimensions are in millimeter										
Pkg type	A	B	C	d	E	F	P0	P	P1	W
SOT-323	2.25	2.55	1.19	Ø1.55	1.75	3.50	4.00	4.00	2.00	8.00

SOT-323 Tape Leader and Trailer

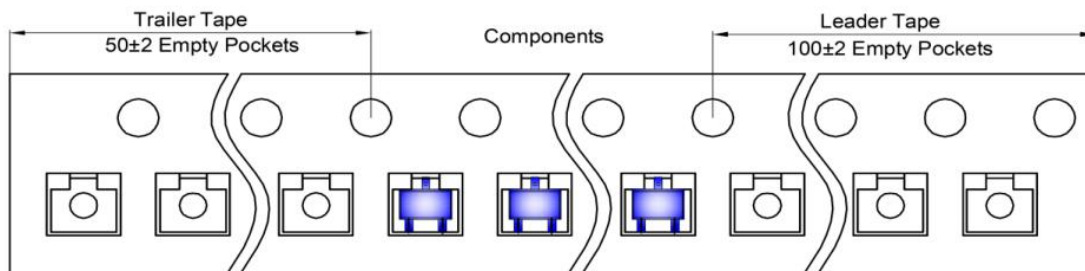

SOT-323 Reel

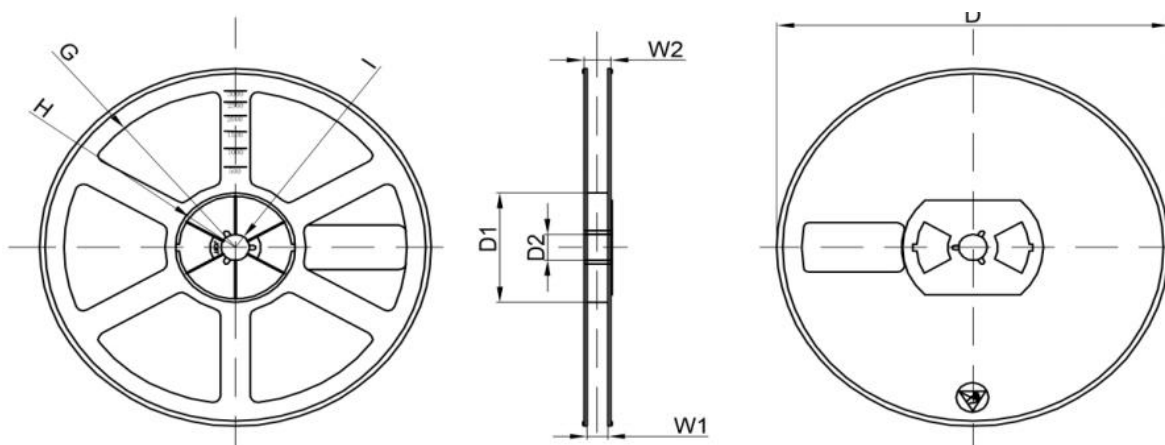

Dimensions are in millimeter								
Reel Option	D	D1	D2	G	H	I	W1	W2
7" Dia	Ø178.00	54.40	13.00	R78.00	R25.60	R6.50	9.50	12.30

REEL	Reel Size	Box	Box Size(mm)	Carton	Carton Size(mm)	G.W.(kg)
3000 pcs	7 inch	30,000 pcs	203×203×195	120,000 pcs	438×438×220	