

2SK3018

30V N-Channel MOSFET

100mA 30V; $R_{DS(ON)typ}=1.1\Omega@4V$, $R_{DS(ON)typ}=1.5\Omega@2.5V$,

FEATURE

- Low on-resistance
- Fast switching speed
- Low voltage drive makes this device ideal for Portable equipment
- Easily designed drive circuits
- Easy to parallel

Application

- Interfacing , Switching

MARKING:

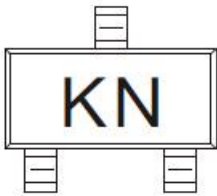

SOT-323

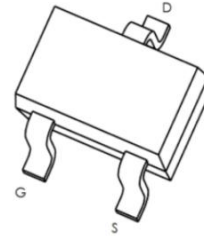

Schematic diagram

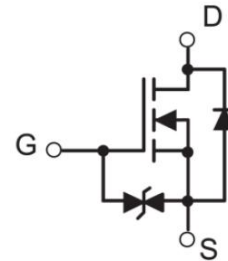

ABSOLUTE MAXIMUM RATINGS ($T_a=25^\circ\text{C}$ unless otherwise noted)

Parameter	Symbol	Value	Unit
Drain-Source Voltage	V_{DS}	30	V
Gate-Source Voltage	V_{GS}	± 20	V
Continuous Drain Current	I_D	100	mA
Power Dissipation	P_D	0.2	W
Thermal Resistance from Junction to Ambient	$R_{\theta JA}$	625	$^\circ\text{C/W}$
Junction Temperature	T_J	150	$^\circ\text{C}$
Storage Temperature	T_{STG}	-55~ +150	$^\circ\text{C}$

MOSFET ELECTRICAL CHARACTERISTICS(T_a=25°C unless otherwise noted)

Parameter	Symbol	Test Condition	Min	Type	Max	Unit
STATIC CHARACTERISTICS						
Drain-source breakdown voltage	V _{(BR)DSS}	V _{GS} = 0V, I _D = 10μA	30			V
Zero gate voltage drain current	I _{DSS}	V _{DS} = 30V, V _{GS} = 0V			0.2	μA
Gate-body leakage current	I _{GSS}	V _{GS} = ±20V, V _{DS} = 0V			±2	μA
Gate threshold voltage	V _{GS(th)}	V _{DS} = V _{GS} , I _D = 250μA	0.6		1.5	V
Drain-source on-resistance	R _{DS(on)}	V _{GS} = 4V, I _D = 10mA		1.1	3.0	Ω
		V _{GS} = 2.5V, I _D = 1mA		1.5	4.2	
Forward tranconductance	g _{FS}	V _{DS} = 3V, I _D = 10mA	20			mS
DYNAMIC CHARACTERISTICS*						
Input Capacitance	C _{iss}	V _{DS} = 5V, V _{GS} = 0V, f = 1MHz		13		pF
Output Capacitance	C _{oss}			9		
Reverse Transfer Capacitance	C _{rss}			4		
SWITCHING CHARACTERISTICS*						
Turn-on delay time	t _{d(on)}	V _{GS} = 5V, V _{DD} = 5V, I _D = 10mA, R _g = 10Ω, R _L = 500Ω,		15		ns
Turn-on rise time	t _r			35		
Turn-off delay time	t _{d(off)}			80		
Turn-off fall time	t _f			80		

*These parameters have no way to verify.

Typical Electrical and Thermal Characteristics

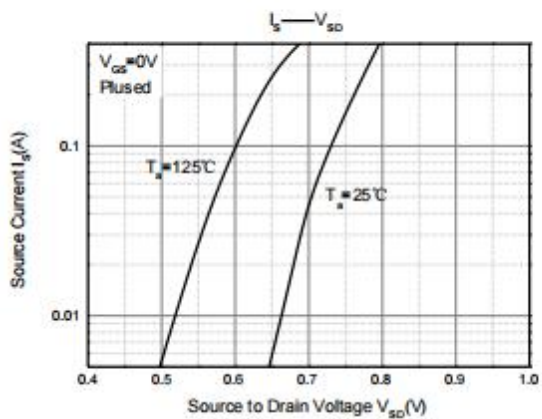
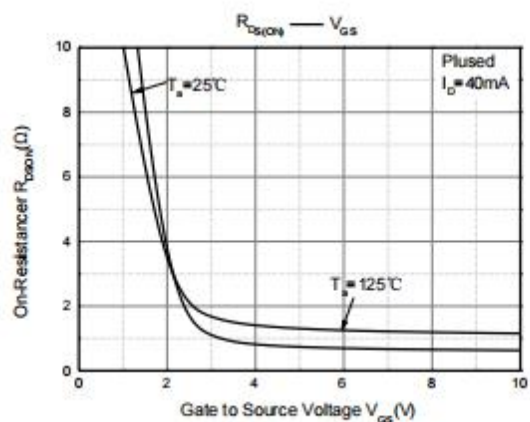
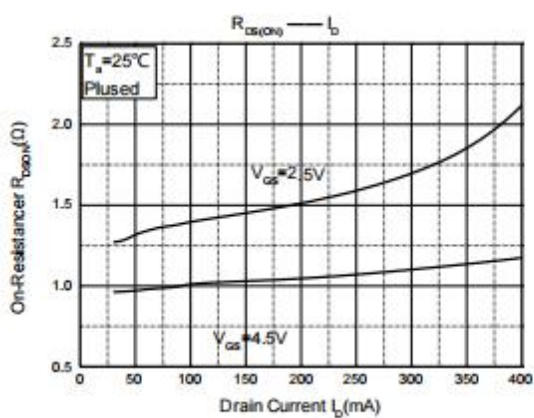
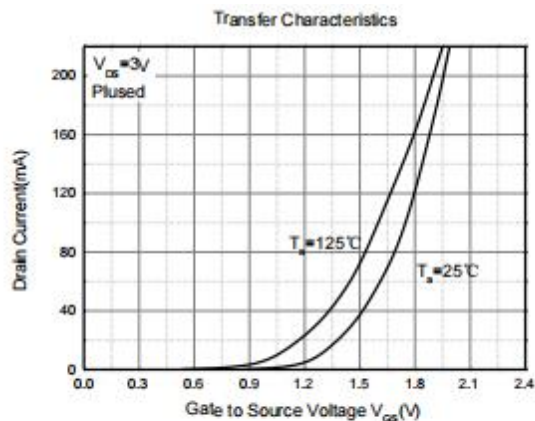
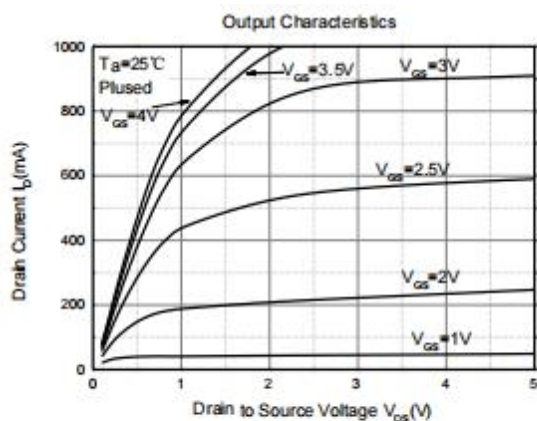

SOT-323 Package Information

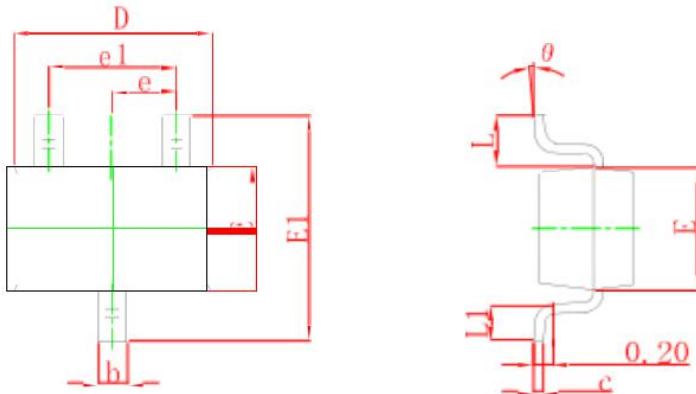

Symbol	Dimensions In Millimeters		Dimensions In Inches	
	Min	Max	Min	Max
A	0.900	1.100	0.035	0.043
A1	0.000	0.100	0.000	0.004
A2	0.900	1.000	0.035	0.039
b	0.200	0.400	0.008	0.016
c	0.080	0.150	0.003	0.006
D	2.000	2.200	0.079	0.087
E	1.150	1.350	0.045	0.053
E1	2.150	2.450	0.085	0.096
e	0.650 TYP		0.026 TYP	
e1	1.200	1.400	0.047	0.055
L	0.525 REF		0.021 REF	
L1	0.260	0.460	0.010	0.018
θ	0°	8°	0°	8°

SOT-323 Tape and Reel

SOT-323 Embossed Carrier Tape

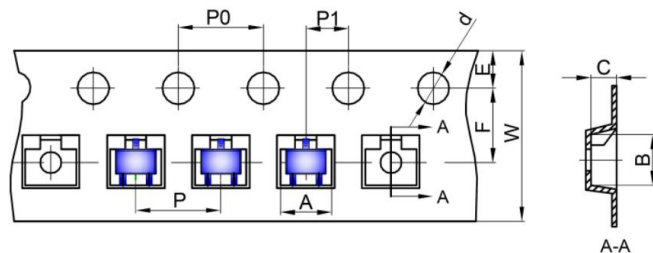

Dimensions are in millimeter										
Pkg type	A	B	C	d	E	F	P0	P	P1	W
SOT-323	2.25	2.55	1.19	Ø1.55	1.75	3.50	4.00	4.00	2.00	8.00

SOT-323 Tape Leader and Trailer

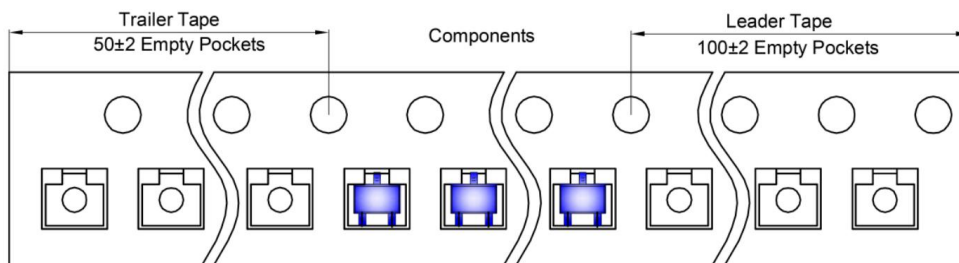

SOT-323 Reel

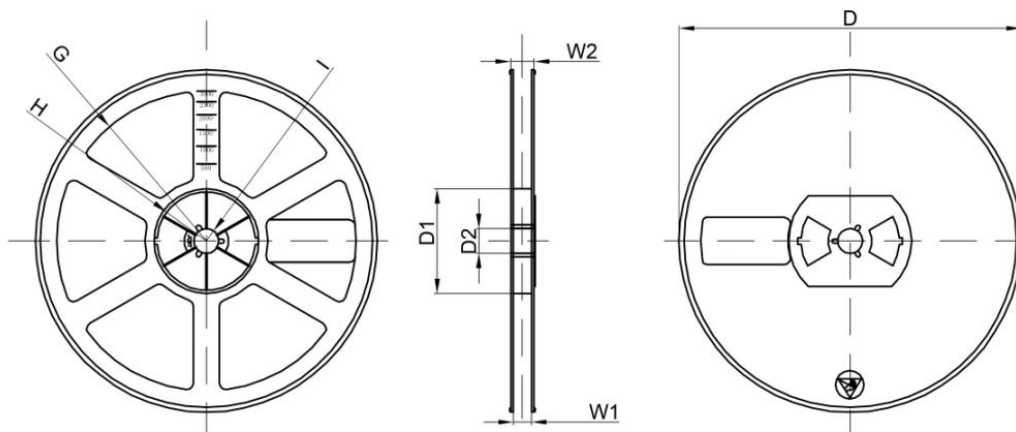

Dimensions are in millimeter								
Reel Option	D	D1	D2	G	H	I	W1	W2
7" Dia	Ø178.00	54.40	13.00	R78.00	R25.60	R6.50	9.50	12.30

REEL	Reel Size	Box	Box Size(mm)	Carton	Carton Size(mm)	G.W.(kg)
3000 pcs	7 inch	30,000 pcs	203×203×195	120,000 pcs	438×438×220	