

PW2304

30V N-Channel MOSFET

3.3A 30V; $R_{DS(ON)typ}=33m\Omega@10V$, $R_{DS(ON)typ}=43m\Omega@4.5V$

FEATURE

- TrenchFET Power MOSFET

Application

- DC/DC Converter
- Load Switch for Portable Devices

MARKING:

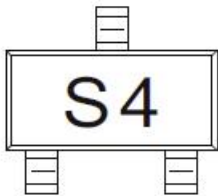

SOT-23

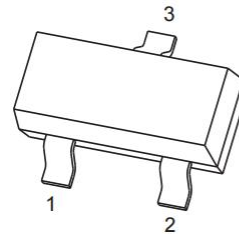

1. GATE
2. SOURCE
3. DRAIN

Schematic diagram

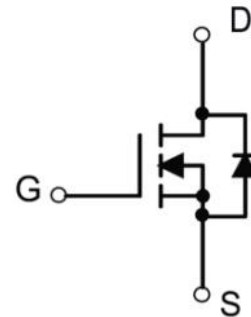

ABSOLUTE MAXIMUM RATINGS ($T_a=25^\circ\text{C}$ unless otherwise noted)

Parameter	Symbol	Value	Unit
Drain - Source Voltage	V_{DS}	30	V
Gate - Source Voltage	V_{GS}	± 20	V
Continuous Drain Current ^{1,5}	I_D	3.3	A
Pulsed Drain Current ²	I_{DM}	13	A
Power Dissipation ^{4,5}	P_D	1.4	W
Thermal Resistance from Junction to Ambient ⁵	$R_{\theta JA}$	89	$^\circ\text{C/W}$
Junction and Storage Temperature Range	T_J, T_{STG}	-55~+150	$^\circ\text{C}$

MOSFET ELECTRICAL CHARACTERISTICS(T_a=25°C unless otherwise noted)

Parameter	Symbol	Test Condition	Min	Type	Max	Unit
Static Characteristics						
Drain-source breakdown voltage	V _{(BR)DSS}	V _{GS} = 0V, I _D = 250μA	30			V
Zero gate voltage drain current	I _{DSS}	V _{DS} = 30V, V _{GS} = 0V			1	μA
Gate-body leakage current	I _{GSS}	V _{GS} = ±20V, V _{DS} = 0V			±100	nA
Gate threshold voltage	V _{GS(th)}	V _{DS} = V _{GS} , I _D = 250μA	1	1.6	2.2	V
Drain-source on-resistance ³	R _{DS(on)}	V _{GS} = 10V, I _D = 3.2A		33	60	mΩ
		V _{GS} = 4.5V, I _D = 2.8A		43	75	
Forward tranconductance ³	g _{FS}	V _{DS} = 4.5V, I _D = 2.5A	2.5			S
Dynamic characteristics						
Total gate charge	Q _g	V _{DS} = 15V, V _{GS} = 10V, I _D = 3.4A		4.5	6.7	nC
					2.1	
Gate-source charge	Q _{gs}	V _{DS} = 15V, V _{GS} = 4.5V, I _D = 3.4A		0.85		
Gate-drain charge	Q _{gd}			0.65		
Gate resistance	R _g	f = 1.0MHz	0.8	4.4	8.8	Ω
Input Capacitance	C _{iss}	V _{DS} = 15V, V _{GS} = 0V, f = 1MHz		235		pF
Output Capacitance	C _{oss}			45		
Reverse Transfer Capacitance	C _{rss}			17		
Turn-on delay time	t _{d(on)}	V _{DD} = 15V, R _L = 5.6Ω, I _D ≈ 2.7A, V _{GEN} = 4.5V, R _g = 1Ω		12	20	ns
Turn-on rise time	t _r			50	75	
Turn-off delay time	t _{d(off)}			12	20	
Turn-off fall time	t _f			22	35	
Turn-on delay time	t _{d(on)}	V _{DD} = 15V, R _L = 5.6Ω, I _D ≈ 2.7A, V _{GEN} = 10V, R _g = 1Ω		5	10	
Turn-on rise time	t _r			12	20	
Turn-off delay time	t _{d(off)}			10	15	
Turn-off fall time	t _f			5	10	
Source-Drain Diode characteristics						
Continuous source-drain diode current	I _S	T _C = 25°C			1.4	A
Pulse diode forward current	I _{SM}				15	A
Body diode voltage ³	V _{SD}	I _S = 2.7A, V _{GS} = 0V			1.2	V

Notes:

- The maximum current rating is limited by package.
- Pulse Test : Pulse Width ≤ 10μs, duty cycle ≤ 1%.
- Pulse Test : Pulse Width ≤ 300μs, duty cycle ≤ 2%.
- The power dissipation P_D is limited by T_{J(MAX)} = 150°C.
- Device mounted on 1in² FR-4 board with 2oz. Copper, in a still air environment with T_A = 25°C.

Typical Electrical and Thermal Characteristics

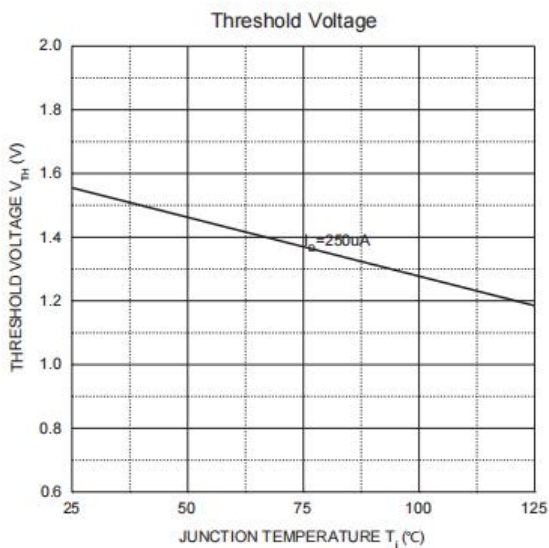
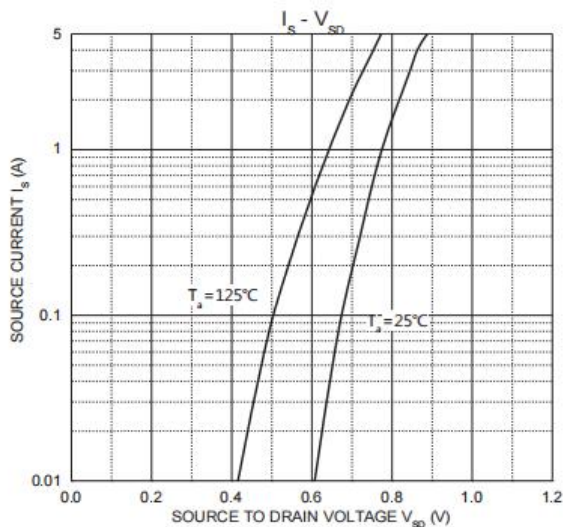
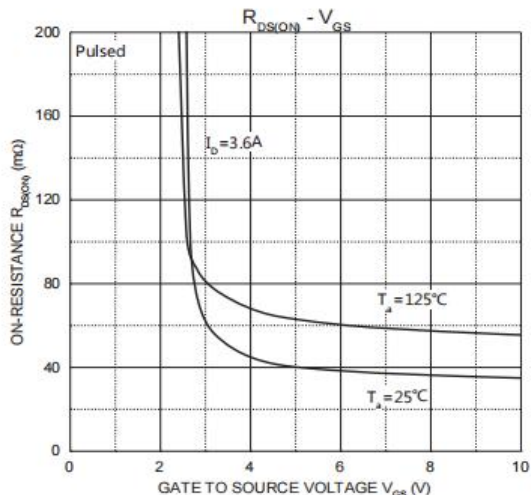
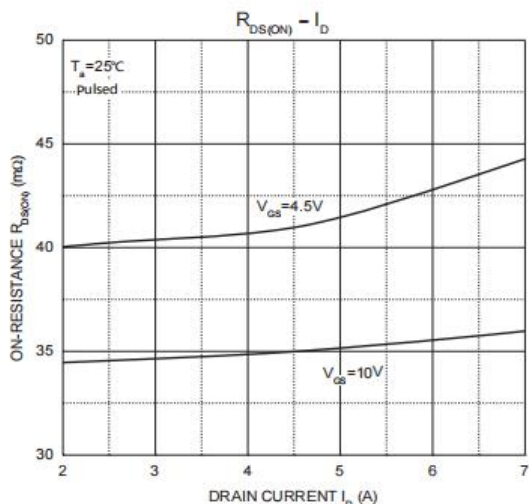
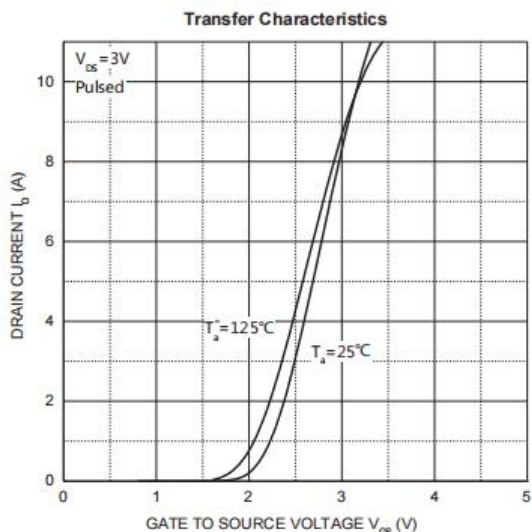
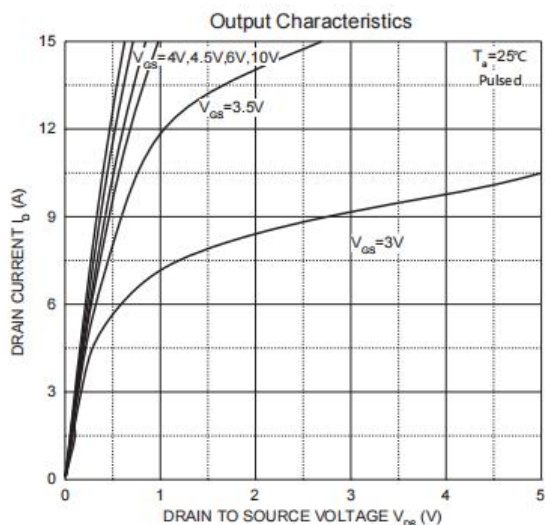

SOT-23 Package Information

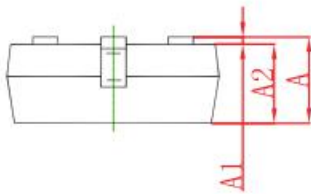
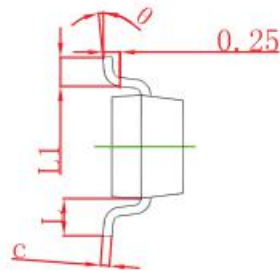
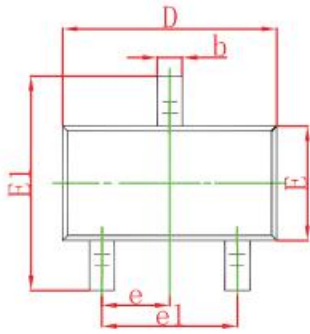

Symbol	Dimensions In Millimeters		Dimensions In Inches	
	Min	Max	Min	Max
A	0.900	1.150	0.035	0.045
A1	0.000	0.100	0.000	0.004
A2	0.900	1.050	0.035	0.041
b	0.300	0.500	0.012	0.020
c	0.080	0.150	0.003	0.006
D	2.800	3.000	0.110	0.118
E	1.200	1.400	0.047	0.055
E1	2.250	2.550	0.089	0.100
e	0.950 TYP		0.037 TYP	
e1	1.800	2.000	0.071	0.079
L	0.550 REF		0.022 REF	
L1	0.300	0.500	0.012	0.020
θ	0°	8°	0°	8°

SOT-23 Tape and Reel

SOT-23 Embossed Carrier Tape

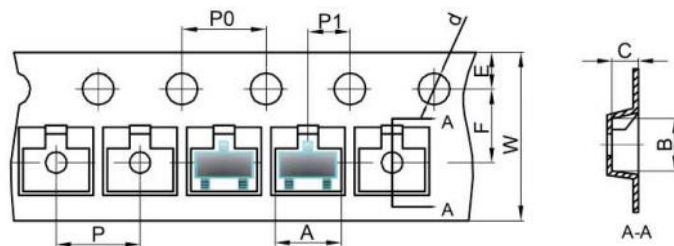

Dimensions are in millimeter										
Pkg type	A	B	C	d	E	F	P0	P	P1	W
SOT-23	3.15	2.77	1.22	Ø1.50	1.75	3.50	4.00	4.00	2.00	8.00

SOT-23 Tape Leader and Trailer

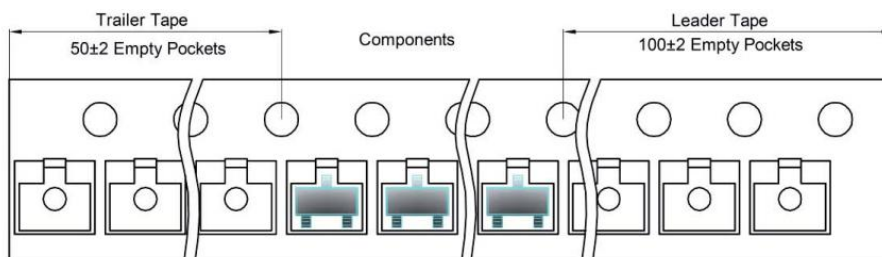

SOT-23 Reel

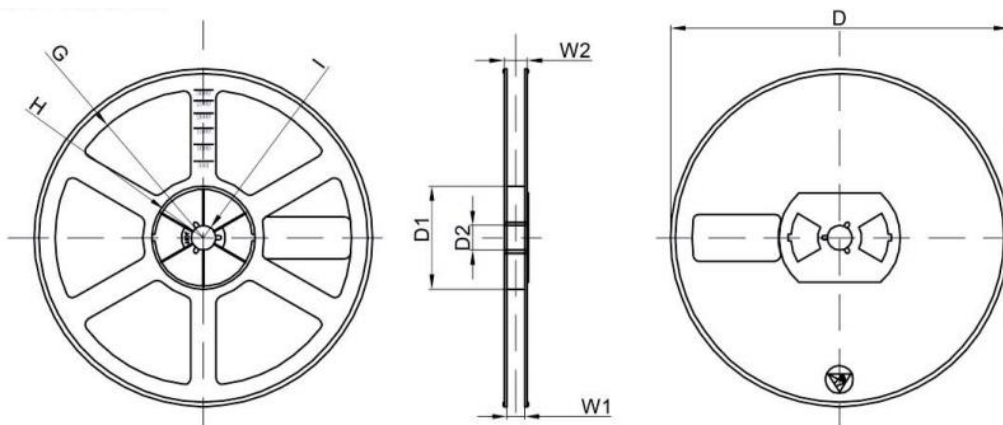

Dimensions are in millimeter								
Reel Option	D	D1	D2	G	H	I	W1	W2
7" Dia	Ø178.00	54.40	13.00	R78.00	R25.60	R6.50	9.50	12.30

REEL	Reel Size	Box	Box Size(mm)	Carton	Carton Size(mm)	G.W.(kg)
3000 pcs	7 inch	30,000 pcs	203×203×195	120,000 pcs	438×438×220	