

PW2324

100V N-Channel MOSFET

2A 100V; $R_{DS(ON)typ}=195m\Omega@10V$, $R_{DS(ON)typ}=200m\Omega@6V$,
 $R_{DS(ON)typ}=208m\Omega@4.5V$

FEATURE

- TrenchFET Power MOSFET
- Exceptional on-resistance and maximum DC current capability

Application

- DC/DC Converter
- Load Switch for Portable Devices
- Battery Switch

MARKING:



SOT-23

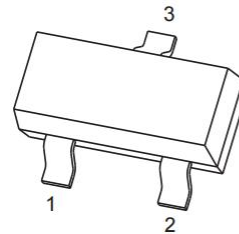

1. GATE
2. SOURCE
3. DRAIN

Schematic diagram

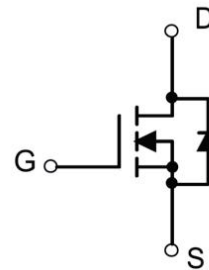

ABSOLUTE MAXIMUM RATINGS ($T_a=25^\circ\text{C}$ unless otherwise noted)

Parameter	Symbol	Value	Unit
Drain-Source Voltage	V_{DS}	100	V
Gate-Source Voltage	V_{GS}	± 20	V
Continuous Drain Current	I_D	2	A
Maximum Power Dissipation	P_D	0.35	W
Thermal Resistance from Junction to Ambient	$R_{\theta JA}$	357	$^\circ\text{C/W}$
Junction Temperature	T_J	150	$^\circ\text{C}$
Storage Temperature	T_{STG}	-55~+150	$^\circ\text{C}$

MOSFET ELECTRICAL CHARACTERISTICS(T_a=25°C unless otherwise noted)

Parameter	Symbol	Test Condition	Min	Type	Max	Unit
STATIC CHARACTERISTICS						
Drain-source breakdown voltage	V _{(BR)DSS}	V _{GS} = 0V, I _D = 250μA	100			V
Zero gate voltage drain current	I _{DSS}	V _{DS} = 80V, V _{GS} = 0V			1	μA
Gate-body leakage current	I _{GSS}	V _{GS} = ±20V, V _{DS} = 0V			±100	nA
Gate threshold voltage ⁽¹⁾	V _{GS(th)}	V _{DS} = V _{GS} , I _D = 250μA	1.2	1.5	2.5	V
Drain-source on-resistance ⁽¹⁾	R _{DS(on)}	V _{GS} = 10V, I _D = 1.5A		195	250	mΩ
		V _{GS} = 6V, I _D = 1A		200	260	
		V _{GS} = 4.5V, I _D = 0.5A		208	270	
Forward tranconductance ⁽¹⁾	g _{FS}	V _{DS} = 5V, I _D = 1A	1			S
DYNAMIC CHARACTERISTICS⁽²⁾						
Input Capacitance	C _{iss}	V _{DS} = 50V, V _{GS} = 0V, f = 1MHz		190		pF
Output Capacitance	C _{oss}			22		
Reverse Transfer Capacitance	C _{rss}			13		
SWITCHING CHARACTERISTICS⁽²⁾						
Turn-on delay time	t _{d(on)}	V _{GS} = 10V, V _{DD} = 50V, I _D = 1.3A, R _G = 1Ω, R _L = 39Ω		6		ns
Turn-on rise time	t _r			10		
Turn-off delay time	t _{d(off)}			10		
Turn-off fall time	t _f			6		
Total gate charge	Q _g	V _{DS} = 50V, V _{GS} = 10V, I _D = 1.3A		5.2		nC
Gate-source charge	Q _{gs}			0.75		
Gate-drain charge	Q _{gd}			1.4		
SOURCE-DRAIN DIODE CHARACTERISTICS⁽⁴⁾						
Body Diode Voltage ⁽¹⁾	V _{SD}	I _S = 1A, V _{GS} = 0V			1	V

Notes:

1. Pulse Test : Pulse Width ≤ 300μs, Duty Cycle ≤ 0.5%.
2. Guaranteed by design, not subject to producing.

Typical Electrical and Thermal Characteristics

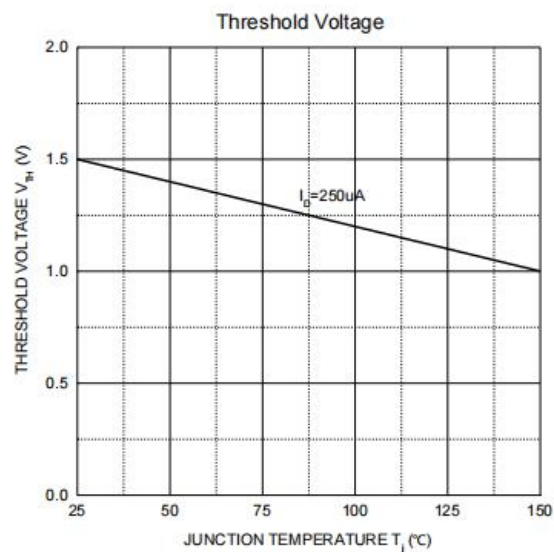
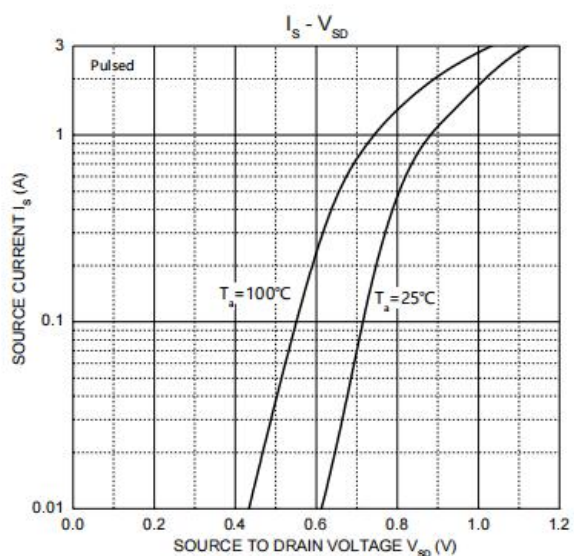
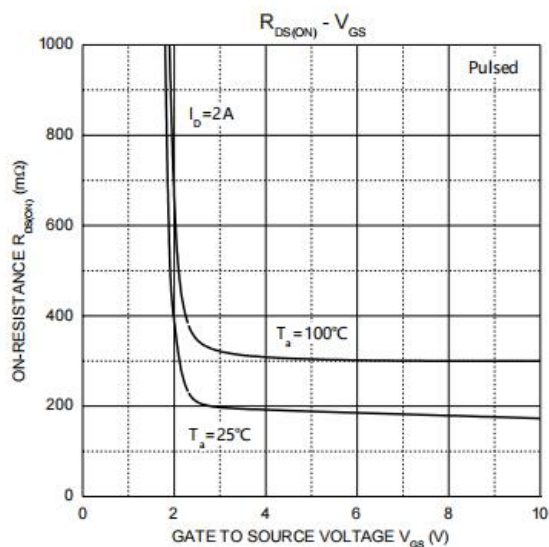
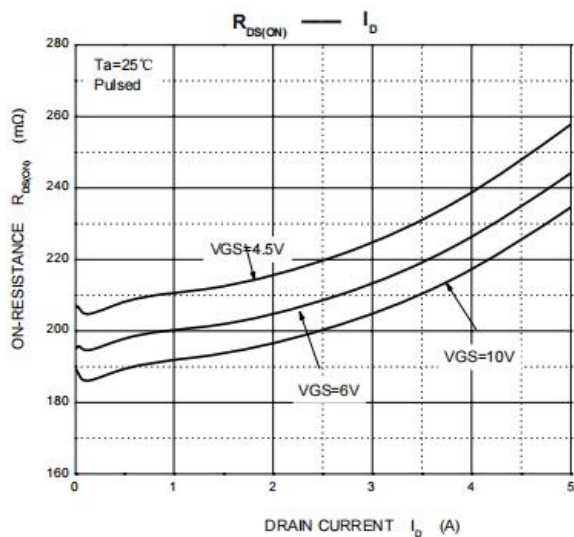
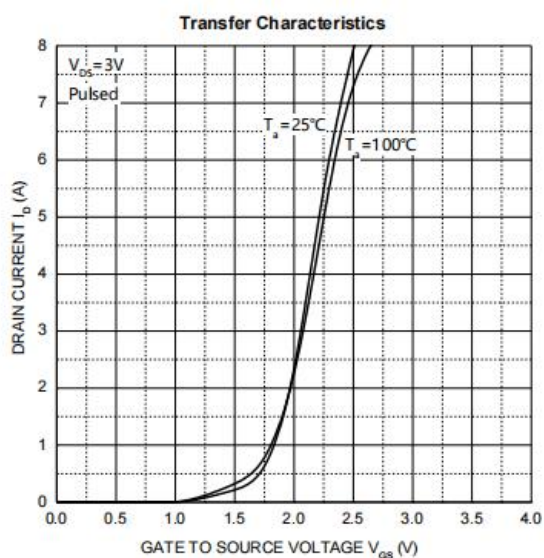
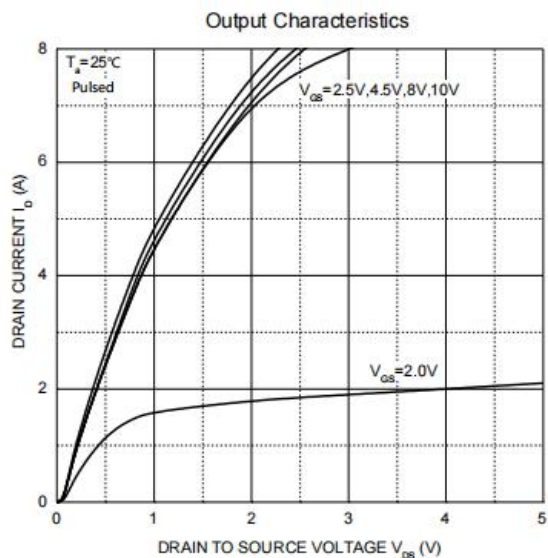

SOT-23 Package Information

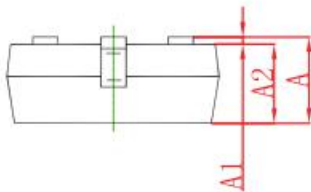
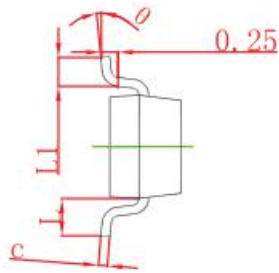
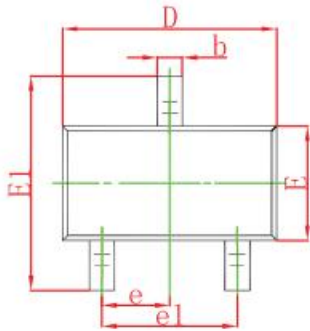

Symbol	Dimensions In Millimeters		Dimensions In Inches	
	Min	Max	Min	Max
A	0.900	1.150	0.035	0.045
A1	0.000	0.100	0.000	0.004
A2	0.900	1.050	0.035	0.041
b	0.300	0.500	0.012	0.020
c	0.080	0.150	0.003	0.006
D	2.800	3.000	0.110	0.118
E	1.200	1.400	0.047	0.055
E1	2.250	2.550	0.089	0.100
e	0.950 TYP		0.037 TYP	
e1	1.800	2.000	0.071	0.079
L	0.550 REF		0.022 REF	
L1	0.300	0.500	0.012	0.020
θ	0°	8°	0°	8°

SOT-23 Tape and Reel

SOT-23 Embossed Carrier Tape

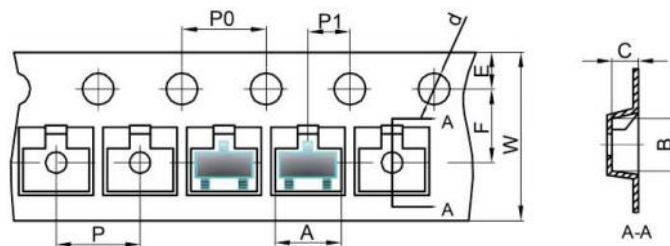

Dimensions are in millimeter										
Pkg type	A	B	C	d	E	F	P0	P	P1	W
SOT-23	3.15	2.77	1.22	Ø1.50	1.75	3.50	4.00	4.00	2.00	8.00

SOT-23 Tape Leader and Trailer

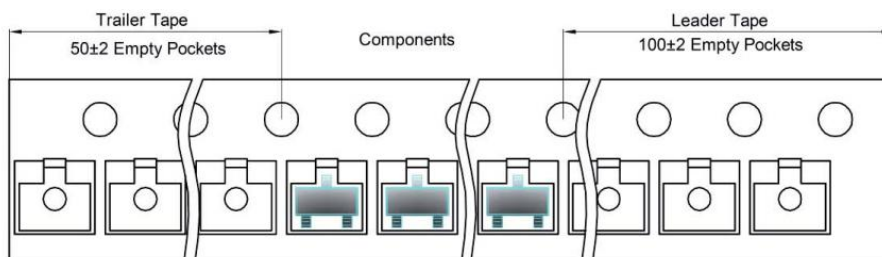

SOT-23 Reel

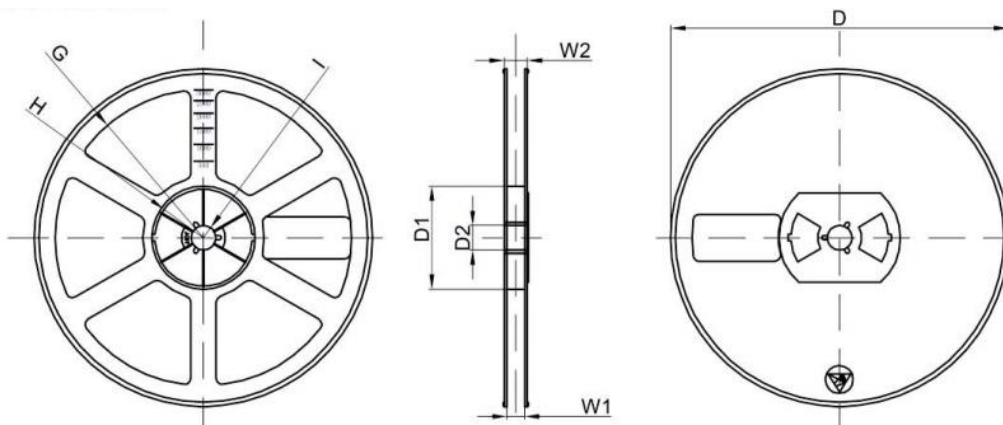

Dimensions are in millimeter								
Reel Option	D	D1	D2	G	H	I	W1	W2
7" Dia	Ø178.00	54.40	13.00	R78.00	R25.60	R6.50	9.50	12.30

REEL	Reel Size	Box	Box Size(mm)	Carton	Carton Size(mm)	G.W.(kg)
3000 pcs	7 inch	30,000 pcs	203×203×195	120,000 pcs	438×438×220	